



*The COOK Report on  
Internet Protocol  
Technology, Economics, and Policy*



© Cook Network Consultants

## **Do-It-Yourself Wireless in Spain and the US**

*Susan Crawford's Captive Audience Impels  
a do-it-ourselves Approach in USA*

**Draft and  
approximate title  
Version 2.5**

Volume XX1, No, 12 & XXII, No 1  
March April 2013  
ISSN 1071 - 6327

# Contents

## Executive Summary

*Why Have a Network in the First Place?* p. 5

## Introduction

*Why the people must take back the Internet*

## Communications and Speech

Taking back Internet access and control in Spain and the USA p.10

Eighty Years Ago Public Interest Demanded Universal Access p.10

## How We Got into This Mess

*& Why We must Build the People's Network Ourselves* p. 11

Why a Government By and For the One Percent? p. 21

## Part One: guifi.net

*Do It yourself Commons Infrastructure in Spain*

## A Bottom-Up Confederation

*As an Organizational Framework for User-built Telecommunication Systems* p. 25

## Guifi Net: The Beginnings

Work in the Spanish Countryside Demanded Broadband p.28

Serious Work on guifi.net Begins in 2000-2001 p. 31

Taking an Expansive Point of View -

Looking for Partner Building for the Commons p. 33

What Top Down Broadband Looked Like –

Telefonica in Complete Charge p. 36

Fiber Becomes Mandatory -- and the

Importance of the guifi.net Foundation p. 38

Understanding How guifi.net Has Grown p. 43

GURB Nord Project Phase 1 2009 p. 46

Description of the first section of fiber in Gurb (FFTF) p. 49

Joining guifi.net in Three Steps p. 51

<b>Use of Google Maps for Virtual Network Planning</b>	p. 55
<b>Growth in Valencia Region</b>	p. 58
<b>Local Groups</b>	p. 61
<b>Gurb Zone</b>	p. 63
<b>The Three Pillars</b>	p. 70
<b>The Supply Chain</b>	p. 71
<b>C4EU Kick off</b>	p. 72
<b>Business Terms: GURB Nord Project Phase 1 2009</b>	p. 77
<b>LocalRet - Good Intentions Go Astray</b>	p. 84
<b>Network Architectural Building Tools</b>	p. 88
<b>Adding Zones and Nodes in North America</b>	p. 94
<b>Treasures Everywhere</b>	p.105
<b>Network Governance</b>	
<i>The Commons License</i>	p.107

## **Part Two: The FreeNetwork Foundation**

### ***DIY Commons Infrastructure in the US***

## **FreeNetwork Foundation Launches Kansas City FreeNet**

<b><i>A Continuing Report May 2012 through January 2013</i></b>	p.111
<b>The Kansas City Experience</b>	p.112
<b>But Why Are We Doing This?</b>	p.116
<b>The Commons and Community Ownership:</b>	
<b>Understanding the “Free” in FreeNetwork</b>	p.116
<b>What Is Different about the Free Network Architecture?</b>	p.118
<b>The Co-operative: Legal and Physical Structures</b>	p.118
<b>The FreedomCenter</b>	p.126
<b>Envisioning Emergence</b>	p.128
<b>Making Headway by Building a Community</b>	p.132

## **It Must Be Done**

***A Summary and Credo by Isaac Wilder***

*p.141*

## **Conclusion**

***Not an End but a New Beginning by Jeff Michka***

*p.145*

**We've got the Tools and Talent: We Are Not Alone**

*p.147*

**Wouldn't it be Far Better to Say "Do It Ourselves?"**

*p.148*



# Executive Summary

## *Why Have a Network in the First Place?*

Why do Americans seem to favor a mythic individualism rather than any form of social collectivism? America began as a nation that worshiped the myth of the power of the individual rather than any concept of the collective good. We developed as a nation of immigrants who settled a continent and whose heroes were those who pushed back the lonely frontier. Consequently, the development of America culture has been different from the cultures of Europe and Asia. Our immediate cultural heritage and national character covers the nearly two and a half centuries of American independence. Families in the United States may have put down "roots" but the very short length of our history means that while we can trace roots back, at most four centuries, to the Mayflower, it is rather easy for families in Europe to go back well over a millennium. The difference in rootedness can be immense.

Meanwhile, the Enlightenment strongly influenced our founding political philosophy. There the foundation of government was based not upon Divine Right but upon the citizen and the right of the citizen to overthrow the government, were it to be oppressive. The Bill of Rights at the time of its writing was uniquely American. "One Nation, under God, with a government by for and of the people." But examination of that sentence must also be tempered by the understanding that our heroes were frontiersmen. Daniel Boone, Paul Bunyan, Davey Crocket, Johnny Appleseed and, in the 19<sup>th</sup> century, the rugged cowboy who used force of arms to protect his family from threat of "savage" indians.

When the great depression toppled our economy and Franklin Roosevelt saved our democracy with his social programs and four decades of prosperity followed, the Republicans as the party of industrial and financial capital and the privilege that went with economic success had a serious problem. After General Eisenhower was followed by Nixon, who had to resign in disgrace, what would they do to find a winner in the presidential contest? When Ford failed to be re-elected they turned, in an age defined by the influence of television to an actor. Ronald Reagan did not have a persuasive intellect but he new how to act and excelled at the role of the rugged cowboy on the American frontier.

In the 1970s American power was seriously questioned for the first time since World War II. The American economy, ever more dependent on oil, faced a situation where the oil came from places not friendly to our way of life. Ronald Reagan was elected as a new American father figure -- someone we could believe in. I argue that at precisely the wrong time in the development of industrial capitalis, when the development of the ideas of FDR were more important than ever and more hated than ever by the Republican Party, Reagan ruled by telling the citizen that he or she was so good and so independent that the best course of action was to stand up to the corporate state by just taking your skills to an employer that would recognize your innate worth. In other words, you too, can still play the role of the independent cowboy.

Considered over the past three decades Reagan's election was a disaster for the USA. The party of a bye-gone day of power and privilege was in control deregulating everything in sight and pumping up the economy by deficit spending. Private interest was rapidly replacing the national and public interest. Media basked in the myth of the "bright shining city on the hilltop." Government was cast as the enemy, the private citizen frontiersman was the hero and the role of the political system was portrayed as getting government of the backs of the private sector which, not surprisingly had only its own interests at heart.

Communism had been the great fear of the Cold war. It was of course the precise opposite American individualism. Reagan was lucky enough to have the Soviet Union crumble under the weight of its own central planning as industrial goods had to rely more and more on the computer and integrated circuits that they did not possess in any quantity. Of course the Soviets also crumbled in part because Reagan spent them into bankruptcy. However by the time GHW Bush Reagan's vice president ran against Governor Dukakis, Reagan's heritage was the one that appeared to say: individual self-interest was the way to go along with financial deregulation - both of them directions that paved the way for the 2008 collapse.

To ignite the Occupy movement, it took the betrayal by Obama of his 2008 campaign for "hope and change" and the failure to get Washington in control of Wall Street. It seemed that the failure to re-regulate or even to prosecute the banks responsible stunned far too few people. By the election of 2012 the commercial internet had for some 20 years been transforming human communication and the development of knowledge on a global basis. What might have been a successful image of American culture as late as the 1950s, some 60 years later had shown itself to be unworkable. The rugged individuals of the fifties were on the way to becoming the serfs of the one percent class for whom economic deregulation had proven to be a goldmine in every imaginable way.

The technology history of industrial capitalism, as written by Carlotta Perez and published in 2002, the year after the first internet bubble collapsed, has made it clear that our government has failed to force her prescribed rebalancing between financial capital and the broader interest of the citizens that in the past had led to what she called Golden Ages. While the internet globally has become a new and critical enabling technology, in 2013 the USA is still rushing madly to place everything involving this technology over to the hands of very companies who are determined to milk it forever in order to preserve their old cash cows. I argue that every month we continue to do this we cut our collective throats a little deeper. Yet impetus is a powerful force. Despite many signs that our unchanged course is a slow motion disaster in the making, we continue onward. At this point, I argue that looking to Washington for any kind of positive change is an exercise in futility.

There is, however, an extremely positive future course that we should take. In keeping with our frontiersman image, we have always regarded ourselves as tinkerers and do-it-yourselfers. Every American youth seemed to regard their adolescent ability to make the family car run better as a mark of achievement. The digital revolution and proprietary systems as applied to cars have pretty much closed this possibility down. Therefore new avenues are needed.

Much to his credit Dave Hughes - the cursor cowboy recognized this as early as 1976. I did not come across this man online until 1980 and met him in person for the first time only in 1981. However, in the early 1980s, as I got to know him well, I realized that he was quite possibly the first American to grasp well the possibilities of home-based businesses enabled by the BBS and then

internet technology. He spread that understanding by being a good story teller and capturing metaphorical images like "electronic cottages" and "digital homesteading." Where some people see first the money making possibilities of the new technology, the Colonel, as Hughes is also known, found social and emotional contexts in which to describe them. By 1991 he had grasped the idea that wireless would become very important. After convincing me to start this newsletter in late 1991 all I heard from him was wireless. I am skilled at connecting people and used these skills to bring him to the attention of Don Mitchell at the National Science Foundation. Eight years of NSF funded projects followed concluding in 2003 when he went to Namche Bazar Nepal as a follow up to my introduction to a Sherpa whom I had met in Nepal in 2002.

The Cursor cowboy had always said that wireless would reign supreme one day. In the sense of a do it yourself personal technology he was absolutely right. Guifi.net reminded me that officially it is technology agnostic, but because wireless was more accessible Guifi.net became the culmination of that technology while all the time had intended to culminate with the use of fiber. Guifi.net emphasizes that its founding priority is really the network infrastructure as a user owned commons and at the earliest possible moment it must switch to fiber which it is already doing. I agree at some point all networks need to include optical fiber, but because wireless technology is highly flexible, relatively easy to install, and not as subject to rights of way issues **wireless begins as the absolute foundation on which the networks we need will be built.** We, the people, must build them and take back power we have seeded to the global corporations.

This issue tells the rise of do-it-yourself wireless which now that the technology -- with another decade of Moore's law pushing it as well as the internet uniting its advocates -- has become so good, and so powerful that small handfuls of people can quickly create very significant change. And note the plural. **One person does not a network make. Many do-it-yourselfers become plural: Do-it-Ourselves (DIO).** I contend as well that DIY wireless, when brought to the USA, will have another major benefit. It needs a community as a foundation on which to grow and prosper. DIY wireless is vastly different from commercial internet because **it will really work only with the creation of an information constituency behind it.** It will become a powerful force here because, its embrace can ameliorate multiple problems.

DIY wireless will appeal to Americans as rugged tinkerers. It will appeal as a means of uniting around local community interest to grow local organizations doing the absolutely necessary tasks of keeping money and jobs local. While two centuries ago we would have communities holding their own barn raisings - now communities can do the rough equivalent by building their own networks where DIO **do-it-ourselves gives every participant ownership and a stake in the outcome. Executed well it can become the lever by which people wrest control over their lives and future from the smothering embrace of globalism while they search for whether a reasonable balance between the two forces may exist.**

In May 2013, I and likely two or 3 other friends will go to Spain, and then to Catalonia and guifinet. To see it first hand and to understand in detail how it works and bring the workings back home. The mission will succeed because the philosophy behind quifi.net and the way in which it is organized will become the requisite foundation in the USA for a future established on the political, social, and economic principles on which our nation was founded. I started this issue as a follow up to the progress of Isaac Wilder whom I met during the hopeful days of Occupy 2011 in New York City.

By chance Isaac asked whether I might also look at other networks mentioning Buenos Aires, Barcelona and Berlin. He said added that guifinet was the largest.

A few days later - in early December - through another network contact from Catalonia, I found myself in the midst of as conversation with Ramon Roca - a guifi.net cofounder. The following introduction will use Susan Crawford's new book, *Captive Audience*, to explain how we got into the mess in which we find ourselves. Next Part One of this issue will be an in depth examination of guifi.net and its breath-taking tools. Then Part Two looks at Isaac's network in Kansas City. As the result of my sharing drafts with Isaac, his group has rapidly gotten up to speed on guifi.net and is now undertaking the steps needed to join the world wide guifi.net confederation. The issue will conclude with an essay by Jeffery Michka that will explain critical issues involved in transplanting guifi.net between two different cultures. The confluence of these developments here is extremely positive and I hope powerful in the midst of an otherwise very bleak social and economic period.

This effort began with no prior goal other than to see what this big ad hoc network in Catalonia was all about and ascertain what if any lessons it held for what Isaac was trying to do. However one thing led to another. When I saw how vast guifi.net had become and that it was self managing and sustaining the light went on and I said to Isaac, "Hey here is your proof of concept. What you are doing is not is not quixotic - it can be done." The recognition that there could be no top down answer - thanks to Ramon's willingness to guide us, led to an understanding of the modular character along with the knowledge of the concept of the commons as a platform. It also led to a realization that here was a group of Catalonians who seemed to have built a working solution to the problems that have eluded us. In the last days of January it became clear to me and my colleagues that we must do it **OURSELVES**.

And suddenly we realize a workable solution had developed along Spain's Mediteranian coast. The bottom up model it rested on was a perfect fit for our needs and goals. Why not visit and find out everything about how it works and bring the ideas back here? Then during the past few days there was an added fortuitous leap. With no advanced planning on my part I had developed such a detailed description of guif.net that it seemed almost like a virtual visit. No longer lets get three or four people together go there study further and bring back a description with the hope that the sale would be made. it appears that a small group of like-minded people acting autonomously can reach a shared conclusion an shave many months off the time it would take a larger group to decide.

Consequently this short book is only the beginning of the coverage of guifi.net that I intend to compile during the rest of 2013.

To encourage the start up of nodes in the US, **The COOK Report** will produce something like a handbook on how it functions and is governed. In the sense of the ideas of Michel Bauwens and the Peer 2 Peer Foundation, guifi.net is an idea whose time has come. Get the right people together who recognize the problem and a solution can self-organize.

***Why have a network? On the American side of the pond it is to bring people together who have been isolated and then abandoned by industrial capitalism and enable them to establish common goals for the community in which they live.***

# Introduction

*Why the people must take back the Internet*

# Communications and Speech

## *Taking back Internet access and control in Spain and the USA*

At the beginning of 2013, the globalized corporate state sets the prices and rules for access to communications and speech in the USA and to a lesser extent Europe. This is a situation that five years ago would have been unthinkable. But now Washington DC has betrayed the application of much of the Bill of Rights to American citizens. While in the name of financial capital Spain has been devastated, in the province of Catalonia a people's network infrastructure owned and operated as a commons called guifi.net took root in 2004 and has spread to more than 20,000 operative nodes as of January 2013.

This **COOK Report** begins its process of chronicling the rise of guifi.net with the goal that Americans may be able to stand up to the corporate state and declare their independence from its growing stranglehold. If we are not to become serfs of the new corporate world order, we must begin to build and own our own telecommunications infrastructure. One that is held together and maintained as a commons. The bad news is that it is late in the game. The good news is that wireless mesh technology backed up by fiber has become cheap enough where it is possible to build. The USA must begin that construction now.

Whether in America or elsewhere in the World, ease of access to means of communication may be taken as a filter through which to view the social and economic priorities of a society. This holds true at levels ranging from the nation state down to the local community. Recent events in the United States have marked a betrayal of these priorities. This issue explains the situation and presents the beginnings of a call to action - one that will be expanded after a direct **COOK Report** visit to Catalonia in May.

## **Eighty Years Ago Public Interest Demanded Universal Access**

Compared to the Internet, access to telecommunications, here in the US during the last great period of economic upheaval in the 1930s was a significant test of where things were headed - then. With leadership that is lacking now, the outcome was influenced along the lines that there are technologies so important that they must be treated as a basic part of the infrastructure of any modern society rather than as purchased goods or services accessible primarily to the wealthy. It was also understood that they were not to become a means for distant corporations to extract profit from the local community. The Communications Act of 1934 prioritized access to telephony under the banner that a communications network became all the more useful given the larger the number of people who could attach to it. Consequently national policy would ensure that, by one means or another, every

American family would be part of the network. Service would be universal.

With the Internet, the stakes were much higher. The Internet was not just a means of voice communication but one of the digital communication of everything -- written language, spoken language, images, pictures, sounds, data and knowledge of all kinds were becoming available to those with the right education, equipment, and connection in ways that could not have been attained two or three generations before.

And yet a twenty year-long debate in the United States seems to have reached its culmination in the year 2012. During this time the creation of a high technology monopoly for the cable television operators divided the United States into respective territories served by only one company in the late 90s. There were two kinds of connectivity: -- a wireline CATV monopoly between homes and business and, for the old telephone companies, wireless connections to mobile phones and small mobile computing platforms known as "smart phones."

The hope had been that these extraordinary technologies would have been treated as utilities in the sense of roads and highways, water and sewage plants, and electricity. Furthermore, these basic platforms were something that was deemed to be inherently natural monopolies in that it made no sense to have different highways for different vehicles or multiple electric utility networks or multiple water works.

It was thought that the networks that were built out in the name of competition and in the name of what is now lost "public" or "national" interests would have to be shared. But as these developments played out against a new Gilded Age background of financial excess, those who built out networks spent money, the more so, to hire lawyers to litigate away the regulatory system, rather than maintain the network or to better the technology itself. By the end of 2012 and the publication of Susan Crawford's book *Captive Audience*, it looks as though the cable providers have established a wireline monopoly and the old Telcos a wireless one for access to our fellow citizens and for the conduct of business and the acquisition of knowledge in the United States America.

Here, as these gigantic corporations became ever larger and after passage of the 1996 Telecommunications Act, acquired a stranglehold over the political process, the technology of the Internet grew from the more primitive dial-up to an extraordinarily more powerful instantiation known as "broadband" where the power of the users' computers and fiber optics could be combined to yield communications channels that would handle, on a global basis: video, audio, data processing and retrieval and -- as the new company named Google delivered its message -- bring access to all of human knowledge.

In the 1980s and 90s, American homes in urban and suburban areas developed two wires - one for the telephone company the 2nd for the cable-TV company. It was assumed that any alternative competition would have to be wireless but, rather quickly, it became evi-



dent that wireless could not compete well with fiber optics and anyone who owned fiber to the customer would have what was called, in a previous era where the regulators had not been captured, a natural monopoly. In the United States with the end of 2012 and the publication of Susan Crawford's book *Captive Audience*, the outcome of the would-be monopolist's battle is sharply and sadly portrayed as an apparent victory for Comcast as the nation's largest cable provider and owner of the victorious wire to the home.

At the same time the telco owners of the older copper wire did, with the full acquiescence of the US government, what would have been impossible to do generations before. That is, they divided up the market between wireline and wireless where Verizon and AT&T - the largest of the reunified telephone companies - would be the monopoly source of mobile communications while Comcast and Time Warner, along with three or four other smaller cable systems, would provide wireline voice to the home along with wireline television and wireline Internet.

Their monopoly of these multiple providers was ensured because their territories were geographic and did not overlap. It looked like a dismal conclusion where the only possible alternative source would be the fixed wireless ISPs that were expanding and doing an amazingly good job of serving their customers. At the beginning of 2013, it seems that there may be an opportunity for huge numbers of fixed wireless providers especially in view of the fact that Verizon and AT&T at the same time were embarked on a campaign to get rid of what was known as the Public Switched Telephone Network (PSTN) as well as the attendant obligations under the law that had guided the PSTN since the 1930s. They were in the midst of what appeared would be successful campaigns to abolish "provider-of-last-resort" laws in the states that were there to ensure that -- with public subsidies ranging into the billions of dollars per year -- service would be available to all Americans living in rural areas. The only problem was at this point in time, expected service began to be much more than just voice telephone calls. It began to be the greater power and higher bandwidth required by an Internet that could carry voice, data, and video. The telcos relied on DSL as a patch to their systems. But by 2010 these DSL systems were soon beaten by DOCSIS standard for cable TV modems powered by hybrid coax fiber systems to the home built out by cable MSOs in the 1990s.

Wireless technology was there but the political and economic power were squarely in the hands of the huge cable providers and the telcos -- the latter of which had been reassembled after their breakup of the early 1980s. It looked in short like a devastatingly done deal that instantiated the power of the feudal lords over the powerless peasants. And those who looked to Washington for help, found themselves looking not at help but a kind of regulatory free hell after four years of the Obama Administration. It became extremely clear that government on the national level was designed to enhance the power and political contributions of the national communications companies. The interests of the ordinary American people had been sold to the highest political bidders and if the campaign to abolish the PSTN were to become successful, it seemed possible that large rural



areas of the US could lose all telecommunication service. If rural Americans wanted modern telecom and internet services, they might just be left to build them on their own. With this issue ***The COOK Report*** points out that we must understand that we are now on our own and that Washington DC will do nothing on behalf of our interests. We can turn to the realization that while many of the early builds of unlicensed wireless technology were mesh networks, the underlying technology has now assumed capabilities that only a few dreamers had hoped for in the 1990s -- the capability of serving as a feasible and reliable alternative to the predatory economics imposed by the incumbent cable providers and telcos.

***With this issue The COOK Report points out that we . . . are now on our own and that Washington DC will do nothing on behalf of our interests.***

Consequently this issue will update the efforts of the Free Network Foundation of Isaac Wilder and his compatriots in Kansas City and it will also tell an even more amazing story of how a band of Catalonians branching out Mao-like from rural countryside into Barcelona developed a do-it-yourself network called guifi.net.

If guifi.net's American counterparts wish to be anything beyond exploited information serfs, we must bring guifi.net here. Betrayed by corporate bought-and-paid-for interests the time has come to build it ourselves and do so now at home and across every nook and cranny of our land. When we can provide excellent broadband in rural or inner city areas that the greedy telcos and cablecos deem unworthy (read unprofitable and inconvenient), we will have an invigorating opportunity to tip the power structure in our direction and avoid exploitation on behalf of absentee corporate share holders and overarching corporate greed..

Before turning to the development of guifi.net, we shall look further at Susan Crawford's *Captive Audience* which offers a better understanding of how we wound up in our current deplorable condition.

**Roger Baig Vinas** Computer networks are key infrastructures (probably \_the\_ key infrastructure) of the 21st century. This argument alone is strong enough for not leaving them to be controlled just by private interests. Fortunately computer network technologies are accessible enough (in contrast to nuclear tech, for instance) to let standard citizens get truly involved. One step further, what we (at least I) like from [guifi.net](http://guifi.net) is the overall concept, i.e. citizens truly involved in an infrastructure management (design, implementation, operation, etc.); this concept can be exported to most of the infrastructures/services I can think of (roads, health system, etc.). Essentially it is about telling the people that with the correct attitude they can do much more than simply pay the bills and complain about how the world is going. The commons concept.

## **How We Got into This Mess**

### ***and Why We must Build the People's Network Ourselves***

Affordable voice communication via telephone to anywhere in the nation and ultimately the world was the critical communications technology of the last century. During the Great Depression of the 1930s when our president had the temerity to say to the bankers "I welcome your hatred," the Federal Communications Commission undertook to ensure that voice-based telecommunications - that is to say the telephone - be extended universally on an affordable basis to every American citizen.

For 50 years the Federal Government, acting through the FCC, oversaw the development of voice communications services as something very close to a national monopoly. They forced AT&T to run it in the public interest in order to fund as universal and affordable combination of brilliant technology development with Bell laboratories and judicious oversight in the public interest defined on the basis that the oversight of voice communications be guided not for the enrichment of a narrow stratum of wealthier of citizens but on the basis that all Americans should have the opportunity to converse with fellow citizens on an open, equitable and yes affordable basis.

In the US there was one phone company -- AT&T. This huge company, for a few decades, ran Bell Labs, at the time, the greatest technology development laboratory in the world. Through government imposed oversight, it and a small group of heavily subsidized subsidiaries kept the most remote rural farmhouse in good contact with the entire nation. And it was run on a stable basis as a non-speculative utility -- a grandmother's stock that you bought and held for retirement.

However technology moved onward and as digital stored memory computers came to maturity in the 1960s and 70s, technologists were quick to see that these new digital computing technologies could beneficially be merged with the older telecommunications technologies. This happened and from the merger we gained packet switched networks that carry both voice and data. Then, with the ascendancy of the IP protocol, we gained the capability to have basically a single digital network transmitting bits - ones and zeros - that could be rendered into voice or into an entire universe of information carrying capability.

In the 19th century the most significant enabling technology was electricity. The first electrical utilities were built on isolated basis in cities around the nation to serve the wealthy elite of the time who could afford the prices charged. As Susan Crawford says in her brilliant new book *Captive Audience*, (p. 258) "by the mid-1920s 15 holding compa-

nies controlled 85% of the nation's electricity distribution and the Federal Trade Commission found that power trusts routinely gouged consumers." "In response, recognizing that cheap, plentiful` electricity was essential to economic development and quality of life, thousands of communities formed electric utilities of their own . . . . As a result of the depredations of the electrical utilities, we came to understand that public goods like electricity (and railroads and highways) must be overseen by the public (and funded by the public) if they are to remain publicly useful and generate increasing economic and social returns for all. Why have Americans stopped applying this thinking to communications?"

This question "***why have Americans stopped applying this thinking to communications***" is the most significant question that is now affecting, in a critical and highly negative way, the control of the Internet in the United States since the internet just happens to be most important enabling technology of the 21st century. In her new book [\*Captive Audience: Telecom Industry and Monopoly Power in the New Gilded Age\*](#), Susan Crawford portrays the development of the commercial Internet over the period of roughly the past 20 years. The book shows how the Internet has, so to speak, jumped the tracks.

In the guise of deregulation, we have a winner-takes-all point of view where the Internet has been sold to the public more as a means of entertainment than as a means of enabling these more crucial civic, economic, and political policy purposes. We have forgotten that it was not entertainment but rather these debates that, during the 1930s, enabled Franklin Roosevelt to pull our nation out of the depression and lead us through a global war guided by a strong and shining definition of the national and public interest. It was this shared sense of national purpose that enabled what became known as the American Century. These were the debates that guided us through 60 to 70 years of prosperity and growth.

## **Embracing Entertainment and Abandoning Public Interest**

Rather than seen as a means of entertainment, the Internet should have embodied the very essence of the term "public purpose" exerted in the public or national interest. This apparently innocuous difference has been lost on American citizens as the Internet has become a technology -- without access to which -- US citizens cannot even apply for jobs; cannot adequately participate in the evolving healthcare and educational system; and cannot have access to informed political or economic debate aqs a result of which our nation is being run ever more for the interests and benefit of the one percent.

By the end of Bill Clinton's second term; George Bush's disputed election and 9/11 the best that our "leaders" could offer to the nation turned out to be the fraudulent sale of Obama's "hope and change". Rather than the promised transformation we were given a "sell-out" as the new Obama administration brought us to a point where after the economic crash of 2008, the telecommunications revolution of the 21st century was transformed into a wide open unregulated economic free-for-all.

Susan outlines what happened. Having spent many millions in the 1990s on a Hybrid Fiber Coax upgrade to their networks by 2000, the cable companies had developed DOCSIS 2.0 and were approaching the point of installation of DOCSIS 3.0 which could provide far higher bandwidth than the telcos' DSL run over a plant of several decades old copper. The cable companies chosen medium - video - of course needed more bandwidth than voice by far.

After the Supreme Court gave the Presidency to George Bush, the Republicans controlled the FCC from 2001-2008. They adopted a strategic position where the ability of video to escape any regulation served to enable a strategic game of content acquisition. Susan shows how Comcast played the content acquisition game far better than anyone else. At the same time, over the 15 years between the passage of the 96 Communications Act and 2010, the telcos, eager to keep their stock prices high by means of minimum network maintenance, played to their forte with mobile wireless voice and data and essentially "abandoned" a copper infrastructure that, as DOCSIS 2.0 moved up to 3.0 could not keep up to the speeds of the MSOs.

Having reported on the entire development of the commercial Internet from 1992 to the beginning of 2013, I have personally witnessed the events that Susan describes. In March of 2006 when Verizon applied for a cable TV franchise exemption in my state of New Jersey, I well remember how their executives pointed out (largely after the session was over) that as they moved to fiber hosts they would not maintain two networks. They would shut down their older obsolete copper-based network known as the Public Switched Telephone Network one that had been regulated since its inception in exchange for their investment in FiOS. They would never ever run two networks.

By the beginning of 2013 that 2006 statement of intent has become all too true. For a while Verizon looked visionary as it rolled out FiOS only after having gotten permission from the FCC to monopolize it. FiOS was a network bringing an architecturally limited form of fiber to the home. Wall Street acted quickly to punish Verizon -- driving down its stock price for its temerity to invest considerable money in a basic upgrade of its network. AT&T, however, did even less. Susan is appropriately blunt:

Under these situations "the cable companies have no incentive to upgrade their core network hardware to ensure that advanced fiber connections are available to every home throughout the country." **(p.260)**

Communications companies describe globally competitive high-speed access as a luxury, just as private electric city companies did a century ago. Yet communications services are now as important as electricity. Today if you asked American mayors what technology they most want for their city, the majority would say " 'affordable high-speed Internet access.' And they want these networks not simply for the jobs created but because the Internet

brings the world to their community high-speed Internet access gives towns and cities on-line commerce and services; the ability to reach world markets, to to learn and communicate invent and innovate,. It brings a wealth of economic activity and information.” (pp. **260-61**)

(Also such capabilities as real-time remote conferences among workers sharing screen space and in widely separated places collaboratively developing strategies and business plans of all types – an activity that enables them to stay at their desks rather than fly off to distant cities. Something that drives their competitiveness. But something that is too much to ask from America’s telecommunications monopolists.)

All around the world, even including in the United States, Research and Education optical networks are government-subsidized. In Europe and parts of Asia they are used with extraordinary effectiveness to help develop pre-competitive research. The United States has an investment in these networks but with anything sounding of industrial policy anathema to political leaders and with our two largest R&E networks having fought each other almost to the death between 2004 and 2007 – the winner (Internet2) existed on hand-outs from Washington DC – the loser, (National Lambda Rail) technically superior to the winner was taken over by a Los Angeles billionaire.

Most Americans don’t even know how these networks are continuing, in Europe, to speed advances in research, in healthcare, in grid and in cloud computing. Hundreds of millions of stimulus funds were invested in educational and community anchor institution oriented network development, none of which has been significant so far; and most of all which has not even entered the debate in the United States.

Susan finds that “the future of startup businesses, independent programmers, computing industry, the quality of life of many Americans, and the free expression online are all in jeopardy; neither business nor people can count on fast, open access to new markets, new ways of getting an education, new ways of gaining healthcare and new ways of making a living. It is clear from extensive evidence around the world that this publicly supervised infrastructure should be made available to everyone and be provided on a wholesale basis to last mile competitors in order to keep speeds high and prices low. Yet vertically integrated, incumbent, monopoly communications providers have every incentive to discriminate in favor of their own communication and content to the detriment of innovation coming from the rest of us, and to the detriment of information flow generally.. America has emerged decades after the breakup of AT&T with the communications system that has all the monopolistic characteristics of the old Bell System but none of the oversight or universality.” (p.261)

“Yet this inequality is not irrevocable. It is not a product of ‘market forces’ absent human intervention. But to fix it a new approach is needed.” (p.261)

**"The 1<sup>st</sup> step is to decide what the goal of telecommunications policy should be.** Network access providers—and the FCC—are stuck on the idea that not all Americans need the high-speed access now standard in other countries" Susan correctly finds the FCC standards for 2020 - 4 Mb per second downloads and 1 Mb per second uploads to be unacceptable. She adds "in a sense, **the FCC adopted the cable companies' plan as the country's goal.** Its embrace of asymmetric access—far lower upload and download speeds also serves the Carriers interests: only symmetric connections would allow every American to do business from home rather than use the Internet simply for high-priced entertainment." (pp. 261-62)

As she then points out other countries have chosen different goals: South Korea, Japan, Netherlands, Hong Kong, Australia and the United Kingdom are among them. While in the US the best we can do is the Gigabit fiber access built in Lafayette Louisiana, Chattanooga Tennessee, and Kansas City Kansas and Missouri.

Susan goes on to point out that a 4 Mb per second goal "gives us what corporate America asked; it allows the cable distributors to assert that they have already made the necessary investments they are poised to provide the richest Americans profitable asymmetrical high-speed access while leaving ample wiggle for their own "premium" bundled services. As a result, the firmly entrenched digital divide, with rural, poor, and minority areas hoping along with publicly subsidized 4 Mb per second services while urban and suburban residents pay as much as they can spare to access high-bandwidth, will remain the status quo. In there America will stagnate, while other countries rocket ahead." (p. 263)

"What does America really need? For starters, most Americans should access to a reasonably priced 1 Gb symmetric fiber to the home networks. This would mean 1000 Mb per second connections, speeds hundreds of times faster than what most Americans have today. The copper-based lines are not up to gigabit task because they cannot handle additional data." (p. 263)

"But as we have learned, wireless connections work well for small screens carrying low-resolution images but cannot support data rates that will be needed for each home. Only fiber will be able to cope America's exponentially growing demand for data transmission" Susan concludes: "Opponents of a minimum fiber to the home requirement will say that no one needs such a fast connection. When municipal networks make fiber available, adoption rates for those connections are very high; even though fiber is a new (and rare) commodity, 50% of customers routinely sign up. **America is a nation of fast adopters and innovators, given the chance; if the infrastructure is there the American market will find uses for it.** But without that fast nationwide fiber infrastructure, America will not be the country that produces the next big idea the next Google, for the world market of fast connections. (p.264)

In her last statement Susan has just hit the crux of the argument that I shall make for the



rest of this issue. ***For most of the last century Americans were a nation of prodigious and talented do-it-yourselfers. And at long last unlicensed wireless technology has vastly improved in performance and lastly come down in price.*** I have followed Isaac Wilder for the past year and noted his remarkable progress. But pointed by him in the direction of the Iberian Peninsula, I have only just discovered guifi.net. One of the most remarkable aspects of its story is that it has shown the feasibility of a distributed owned do-it-yourself mesh-based wireless network that even now is beginning to connect to fiber and, when blocked by the local incumbent, is beginning to self-fund the installation of its own fiber.

I shall argue that after the extraordinarily disappointing events of the past two years where ***the FCC has betrayed the long-term interests of the 99% of Americans—the only reasonable course is to throw down the gauntlet to the centralized authorities in Washington DC and state capital and say to hell with the 1%, we shall take charge of our own future we shall build our network infrastructure ourselves.***

The execution of this political strategy and maneuvering just outlined is laid out by Susan along with the horribly disappointing betrayal of our national interest which the Federal Communications Commission regarded as nothing more worthy than the unregulated pursuit of profit. The result has been a situation where this most critical new utility was created and treated not as a sacred trust but as a monopoly, subject to the control of the highest bidder and as a means of ensuring a society divided by the economic control exerted by what has popularly become known as the 1% operating at the expense of the 99%.

This issue of ***The COOK Report*** will show basically what appears to be left to the nation that has let its infrastructure slip into decay, that has failed in its political leadership and created a system that will be hostile to technology innovation since it has enabled the largest corporations with greatest control over the existing system to maintain the system as a monopoly and as one where introducing innovation will be extremely difficult because the monopolist controllers will be hostile to anyone with new ideas. New ideas whose implementation could interrupt the stable cash flow ensured by an evermore sclerotic monopoly system are anathema in such a situation.

It will take the point of view that our government has been captured by the wealthy would be monopolists and that the regulatory guidance that once was there to ensure the interest of a more egalitarian public has been vanquished as well. We have a situation where the remaining regulators serve a brief tenure in jobs on behalf of the companies they regulate, expecting to go on to a reward of lush employment by those very companies. As Wall Street has gone, so has telecommunications

At one point in our society, perhaps a century ago the role of the government was to pro-

protect the interests of the most broad economic segment of its population. Now things have changed to a situation where government has abandoned any such pretext. The very companies that offer a vital economic service now enjoy the ability to deliver it as a monopoly. They are free to deliver the service to those people who can pay the rapidly increasing bill --with lesser versions of the service left like crumbs on the floor for the rest of the people to scurry around and attempt to pick up.

In what has been termed as a more progressive era, the role of the government, the role of Washington DC has been to ensure access to public utilities like water and sewer services; highway rail and other transportation services; electricity, and water, and sanitary services necessary as part of the most basic infrastructure of a modern functioning society. While all of that is under siege, telecommunications in principle has fallen under the control of a new class of would be feudal overlords who will not hesitate to use that control to accelerate what many critics see as a march toward serfdom on the part of the less fortunate 99% of the population. I argue that our politicians, whose allegiance has been bought by the largest corporations are smoothing the pathway to permit a new corporate feudalism to run American society and our economy and increasingly to do the same throughout the world.

***The main focus of this issue will be to point out the necessity for citizens who do not like the current direction of things to, in effect, just do it themselves.*** With the commoditization of integrated circuits and evermore sophisticated use of radio frequency technologies - wireless systems are being built that can replace our current monopolies but that, the only way this will happen is ***if sufficient numbers of us recognize the critical importance of stepping up to the plate and taking matters into our own hands.***

I will look at two examples - the first in Europe where we see guifi.net on the Iberian Peninsula and the second by Isaac Wilder of the Free Network Foundation just starting out in Kansas City Missouri. As Roosevelt did in the 1930s with the Civilian Conservation Corps; so now we need to do it on our own. How? Perhaps by forming our own young geeks corps to go out and emulate what the Catalonian's have done? This issue will show how they could begin to build their own system free of corporate control in rural areas of the United States by starting out to build web meshes in every backyard. We must rise up and say to the huge corporate monopolists ***"we shall link together and we shall overcome your government sanctioned predation."***

With Julian Assange is still under arrest at the Ecuadorian Embassy in London, we have also to face the necessity of purging this control by means of independent and "bottom up builds" of our own networks before the security details of our hollowed out "nation states" clamp down on us all through the security state's control of our top-down structures of power.



## Why a Government By and For the One Percent?

What has happened that has allowed this shift in the balance of power from the early 1960's when President Kennedy could inspire a younger American generation to serve the interests of their fellow Americans? Why the shift to the present time when the government, as an elite ruling class, exists to serve the interests of their global corporations in what under the guise of building "earnings" for the share holders represents an abandonment of what once was a shared concept of the public interest? Instead the elite is enabling both the financial and telecommunications systems to become predatory in form. Consequently - driven by the desire to extract ever more money from their customers - whom they can abuse since they have maneuvered the government into granting them a monopoly via division of the market into wired versus wireline. The cable providers, led by Comcast, control the wire while the incumbent telcos ATT and Verizon control wireless. Cable providers and telcos cross sell each other's product. We are back to the days of the oil robber barons and in Washington no one cares.

Susan Crawford tells the very complicated story in a way that no one has before attempted because she is the first to chronicle the victory of cable TV also known as the MSOs or Multiple System Operators. We live in a time when there is less reason than ever before to trust our government. In a time of media consolidations, the only reason that most of us know there is something other than the "official" reason for events are the citizen blogs and news portals that the internet has enabled to flourish. Matt Taibbi's writings for *Rolling Stone* and Yves Smith and others in the website *Naked Capitalism* are much more informative than the *New York Times* or Rupert Murdoch's *Wall Street Journal*. And yet the FCC, having betrayed what was once called the "national interest": is on the verge of allowing Murdoch to buy more media.

Crawford also shows how a behemoth like Comcast was built in such a way as to become the Standard Oil of the 21<sup>st</sup> century. Media dare not take a path independent of Comcast or, in our 500 channels of 24 by 7 entertainment, their message will be smothered. Susan gives the determined reader an outline of how, like the proverbial frogs, we have been slowly boiled.

She points out that from a policy viewpoint "the crisis in American communications bears some similarity to the banking crisis and to global warming: it has taken decades to arrive; it has happened through incremental policy decisions; mergers and changes in society; it involves technical terms that enable easy obfuscation; large entities have an interest in maintaining the status quo; and there is a great deal of political bluster about possible effect of regulation on innovation and investment." Finally, "in the communications industry, no signal crisis -- no equivalent of the banking collapse -- has erupted to trigger public outrage." (p.11)

Those of us who thought the FCC role was as a watch dog for the public rather than private interest were soon greeted with a rude awakening. "When the telephone was the dominant medium of exchange US law required that every American have access to a phone along with other utility services such as water and electricity. Although Internet has become the common medium of our era and no one can get a job or apply for benefits or keep up with the rest of the world without high speed access, this service is framed as an expensive luxury he reserved for the rich; fully a 3<sup>rd</sup> of Americans don't subscribe to high-speed Internet access and non subscription is highly correlated with low socio-economic status . . . . So the much-needed economic boost that comes from creating and marketing the next big thing will go elsewhere. But few people with power to change the situation seem to understand this." When the monopoly service is selling a must have addictive product at an 85% mark up, it has every incentive to see that nothing new may challenge its dominance. And it will have, by dint of sheer size alone, the ability to stamp out any challenger. **(p12)**

Three paradigm shifts enabled the Comcast NBC Universal merger. They happened between 1996 and 2010. Of the three "the first the big new idea behind the Internet was that its language – and language is all the Internet is, a couple of simple agreements that allow computers to "speak Internet " – facilitated a general-purpose global open network of networks." The Internet as an event that has changed two billion lives around the world is becoming the single common digital platform for communication. **(p12)**

Second, the cable and telephone companies across whose wires Internet talk was flowing made a successful concerted effort to persuade the FCC to ***completely deregulate provision of the two-way, general-purpose communication on which the country's economic, cultural, political and social life depends: high-speed Internet access.***

Third, the newly elected president Barack Obama, seemed to understand that high-speed access was essential for anyone wanting to participate effectively in the 21<sup>st</sup> century global economy. . . . He suggested that non-discriminatory ubiquitous connections were essential – or he seemed to. It looked as though government intervention to ensure world leading reasonably priced wired open Internet access for everyone would be an important priority for the new administration." But Susan concludes: ***"things did not turn out that way for range of reasons that I hope to make clear in this book. Consequences of this failure and policy are likely to be a drag on American success for generations."*** (p.13)

I argue that the government marked especially by the Obama FCC has betrayed the interests of the 99% of Americans. Comcast owns the content and the pipes that do the distribution. Economics dictate that it will favor its own view of the world. Susan points out: "the hearing held to provide oversight of the Comcast NBC merger proposal mask a profound, little-understood American problem ***the lack of supervision over the mammoth companies that sell American access to all information all communications all***

***entertainment all the things that make today's economy, politics, and society function."* (p.14)**

Once there was separation of different media: television, voice, and text. Now thanks to the rise of digital technology and the advent of the Internet they have become lightly differentiated uses the same physical connections. Consequently the question of who controls the wires is about the issue of who controls the connections that unite the economy, politics, and society' **(p.16)** In short we had "a gigantic company providing essential infrastructure for every American, a shifting media landscape, a deregulated environment, and a smoothly operating political campaign built on decades steady effort made it impossible for federal officials reject the merger out of hand: the Comcast- NBCU narrative offers a cautionary tale about what has happened to communications in America." **(p 18)**

Susan concludes that the only hope we have left is in our municipal networks as exemplified by Lafayette Louisiana, Chattanooga Tennessee and Kansas City, Missouri and Kansas. So far so good, but those efforts often been successfully challenged in court. I argue in this issue that -- in view of our betrayal -- we had best turn away from our "bought-and paid-for" central purveyors of power and just do it ourselves. This issue shows how we may begin. How we must take from what guifi.net offers and let a thousand Isaac Wlder's network commons be built.

# **Part One: guifi.net**

## ***Do It yourself Commons Infrastructure in Spain***

# A Bottom-Up Confederation

## *As an Organizational Framework for User-built Telecommunication Systems*

By a “bottom up” plan and design, along with good timing, the founders and organizers of guifi.net have created an extremely powerful. organizational framework for user-built telecommunication systems. After about seven weeks of intense study of their history and accomplishments by means of an extended interview and follow up conversations and email interview with Ramon Roca, a co-founder, and by probing in some depth of their amazing website I conclude that they have built a Wikipedia-like organizational framework of affiliation and confederation.

I suggest that this framework could be used by build-it-yourself telecommunications advocates as a point of attraction for enabling other would be network builders. The only requirement for confederation is that network infrastructure be held and [operated as a commons](#) to craft and document plans of action appropriate to their respective geographical areas no matter where in the world they may happen to be located. Given that this form of organization has not been a mainstream way of doing things in the US, advocating its adoption here necessitates a thorough understanding of its operation. One that can be obtained only by an onsite visit that we shall undertake in May.

***This user-built infrastructure is held together as a commons.***

Meanwhile what emerges from intense study of what they are doing and have done, as reflected in their website is the availability of a decade’s work in [open source infrastructure building](#) that is available by affiliation to all newcomers. This user-built infrastructure is held together as a user-owned commons. The commons is held together by appropriate mailing lists, with excellent backend databases that invite inquiry sharing by new affiliates. To participate all anyone need do is create a login and password. Then, as with a wiki, one is trusted to add content. Critical parts of infrastructure code have been built in such a way as to be shareable by new affiliates.

***What they have achieved is a body of work that network builders can use to leverage fresh investment of time and resources*** in devoting what Clay Shirkey calls their “cognitive surplus”-- a surplus notably in the hands of large numbers of under-used laborers in countries like Spain and the United States. What we have here are the critical points of attraction that can transform themselves in to a much-needed infrastructure building global effort in a manner similar to what *Wikipedia* did a decade ago. This is a

blueprint for a body of material that can be used to lay out the coordinates of the necessary kinds of action that must be taken in order to build new nodes and backbones of what becomes a citizen's infrastructure. This must be done in order to take back the promise of the Internet from the hands of global, corporate-capitalism by which it has been co-opted and betrayed by the political and regulatory bodies of the countries of the users where the elites have built a top-down and economically extractive means of control.

A critical question before us now is what becomes of the Internet, sold as part of entertainment packages to a passive populace by corporate controlled predatory groups. How does one oppose the Internet as a means of entertainment delivered on a platform with a message of user passivity that lulls its audience into acceptance of its fate? The Internet must unite rather than isolate its users at the edge.

The guifi.net confederation delivers power to the edge via a bottom up [construction of "zones"](#) that can be remotely user defined. Ramon, in a Skype conference with Isaac Wilder and myself on January 3<sup>rd</sup>, showed us how this is done. Under the existing American Zone we created a United States Zone and then a New Jersey zone. Under New Jersey we created one for Ewing Township and my house at 431 Greenway Ave became the first United States node. I shall present this, in much more detail, in a later section.

For now, the key is to understand the commons definition of infrastructure and how it helps the local economy by keeping money local.

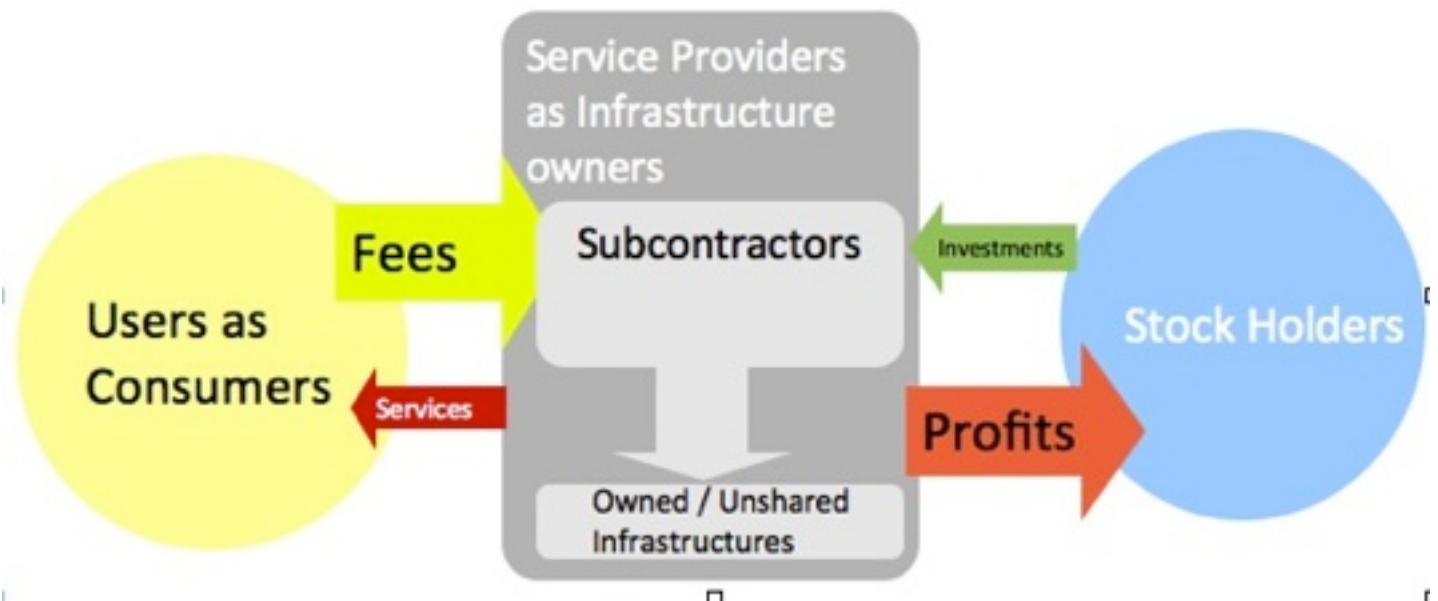

## The Old Way as an Extractive Model

Service providers -- [Telefonica](#) in Spain

--- MSOs; ATT; and Verizon in US

Give bottom up control to like-minded groups at the edge and network users become direct stake holders in the network as a 'glue" that defines the relationship of their community to the world. Service providers come from the local community and are attendant to its needs and view in a way that workers in a call center in a foreign country can never be.

## The Commons -a 21<sup>st</sup> Century Return to a very Old Concept

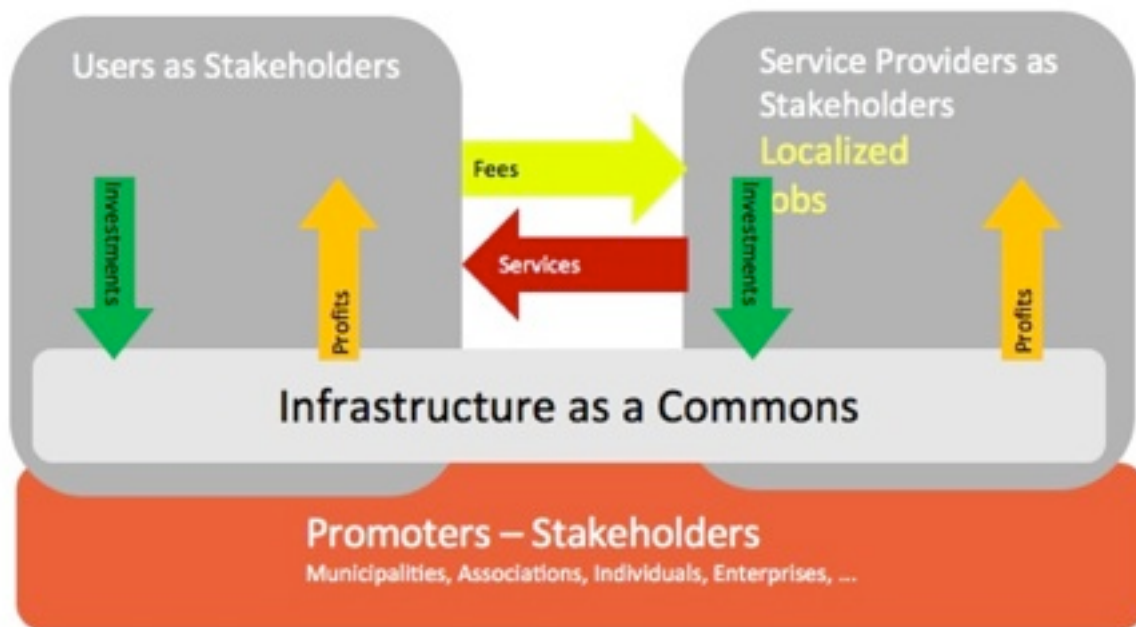

## Commons Model

I suggest that this is a creative platform that is very much needed for many economic models these days. Any profits are invested in rebuilding and improving the infrastructure. The member of the commons gets better service because he or she has an immediate and personal stake in whether good service is or is not being delivered I will explain it in more detail at the end of my treatise on guifi.net.



# Guifi Net: The Beginnings

**Editor's Note:** Ramon Rocha is an employee of Oracle, a native Catalanian and the President of the Board of the guifi.net Foundation. As he says - "I try to avoid that title. I am one of the founders but only one. Member of the Board is quite enough." I interviewed Ramon on December 6 via Skype.

**COOK Report:** Please tell me something about your background and how you came to be a key person in the building of possibly the largest Wi-Fi network in the world.

**Roca:** I'm already pushing fifty years of age and have been working as a techie in the ICT industry for about 30 years. I worked for Oracle and spent quite a few months in San Francisco between 1993 and 1996. In 1996 when I received a permanent work visa I had to definitely decide between of being an Oracle employee in Spain, or the US: After talking with my family, the final choice was to become based permanently in Spain. When I joined Oracle in 1993 it was a small company I not much more than a startup.

**COOK Report:** Were you still working for Oracle when you returned to Spain?

**Roca:** Yes I was still working for Oracle because you know I'm basically a technician. I was not one of those young guys who were operating in the startup mode in the 90s and not at all typical of the people who would leave Oracle and go to Netscape to in order to strike it rich. I was motivated primarily by the challenges of my job and not at all by secondary things like stock options. For me one of the benefits of globalization was the fact that I could return to Spain and build a family and a house and good quality of life and could still work very handily for Oracle from virtually anywhere in the world.

**COOK Report:** What kind of work were you doing for Oracle?

## Work in the Spanish Countryside Demanded Broadband

**Roca:** After 20 years at Oracle I had done almost everything except working as a sales rep. Technical support, engineering, developing, consultancy. Right now my job title is enterprise or industry architect. I am there to make sure that complex technical projects work well and satisfy whatever needs customers have. My clients were mainly in financial services and the public sector.

But when I got back in the late 90s and started working from outside of Barcelona, I found out very quickly that a good broadband connection to the Internet was absolutely necessary for me to do my work at my home without having to try to commute for hours alone in a car by myself to work in an office complex with its own corporate broadband connection. I also realized that it was not just myself and the kind of technical work I was doing but that a good Internet connection for everyone: farmers schoolteachers govern-





**The large house above belongs to Ramon's father. The smaller, more modern house below is what Ramon built for his family after returning to Spain. In the picture below his father's house may be seen in the background to the extreme left. Ramon makes the point that good telecommunications infrastructure allows multiple generations of family to stay together should they desire to do so.**



ment employees, you name them, was increasingly mandatory for living and working as an up-to-date professional public service or business person.

When I got back to Spain and built my house, I realized that I had to get connected and indeed well-connected. Consequently, at this point, I started doing point-to-point shots with wireless links and I started building my own antennas. To find solutions in a rural area I had to pretty much do everything myself. What came out of all this was a very strong do-it-yourself philosophy.

**COOK Report:** Where were you in Spain?

**Roca:** I was 100 km outside of Barcelona. I was actually closer to the border of France than I was to Barcelona.

**COOK Report:** How did your participation evolve?

**Roca:** In my particular case my motivations were as a hobby and the need to do heavy-duty technical work from the countryside rather than having to try a long daily commute to Barcelona. It would have been useless to ask the incumbent, Telefonica. They would have very quickly told me: you are far too many kilometers away from the nearest copper-based exchange point. DSL wouldn't work and that's all they had to offer.

At this point there were already many wireless communities.

**COOK Report:** Well I am by no means a specialist in wireless but I had a friend named Dave Hughes from Colorado who in 1992 and 1993 when I first started my newsletter was very interested in wireless. I did some basic research on his behalf and in January of 1995 and made a contact with the National Science Foundation that resulted in his getting for him in the fall of 1995 for what turned out to be a total of about seven years of well-paid work as a principal investigator for the founding and construction of some very early wireless projects.

I am back into writing about this again because of a new friend, much younger than Col. Hughes, a man named Isaac Wilder who was part of the original **Occupy Wall Street** contingent. Isaac's current story shares part of this issue with you. He was the person who told me about guifi.net and advised me to look into what is going on in Catalonia. I also have the impression now that technology developments are enabling mesh wireless to scale in routing and in other ways that it never could before and that slowly but surely it may be becoming a real alternative infrastructure for people who either can't afford the corporate monopolies or do not wish to be dependent on them.

So tell me more please about how your communication needs, while working for Oracle quite far outside Barcelona, started you off on a journey that morphed in to the creation of guifi.net.

**Roca:** It was in the year 2000-2001 that I began to work with and discover local wireless activity in Catalonia. In looking at what these early developers were doing, my conclusion was that many of them were not very successful in the number of subscribers they attracted or in building a sustainable business operation,

There was one in Barcelona called Barcelona Wireless which after a couple of years disappeared. Of course there were many technical issues to be solved but more important than

these issues were the social and economic considerations needed for it to become sustainable. They were very confident in their technical ability which was tendered on a volunteer basis. But they found that the economic and social issues that faced them in their effort to make something sustainable on a volunteer basis was extremely difficult.

## **Serious Work on guifi.net Begins in 2000-2001**

**COOK Report:** How did you overcome this problem?

**Roca:** While guifi.net was founded in 2004, we were not one of the first wireless groups. This meant that we had the opportunity to learn from the mistakes of our predecessors. Let me explain in more detail. What happened when I got myself connected at my home to the Internet in approximately 2002, my neighbors came to me and said: "this is very good how did you do it? We would like to have such a connection too. Would you help us?"

Now when I talk about "geeks," while there are tens of thousands of us around the world, you will be lucky if you find only one or two in every village. So I understood at the time that in order to build sustainable connectivity I needed to be inclusive when my neighbors came to me and said "Ramon how did you do this?" While I was glad to see other people interested, I knew that these other people, no matter what, would still be a distinct minority and I realized that I better figure out a way to help them. I thought of the old expression that it is much better to teach people how to fish rather than to just supply them with fish by means of your own labor.

So when people said to me "if it's necessary to pay an electrician or some other professional to come to my home and do this, I want it badly enough that I will pay some one," we told them it's not that difficult. We will show you how or, in some cases, we realized it would be a good idea for us to teach professionals how to provide the services for them. This turned out to be quite a key issue. Namely that any telecommunications infrastructure that we would build we would do so in the space of an open commons where everything was open and copyable and nothing was closed and proprietary.

***Furthermore that no one person or small group of people would own the entire infrastructure because it would be created as a public infrastructure as a commons accessible to everyone. To be more specific [guifi.net](http://guifi.net) nodes are in commons as long as they are connected to [guifi.net](http://guifi.net) (as a consequence of the [guifi.net](http://guifi.net) license) but I keep the ownership of what I connected and I can retrieve them whenever I want.***

We explained to people that they would have to build their own pathway to reach every town and that we would be there to make certain, to the maximum extent possible, that every pathway built would have another little village with its own pathway to interconnect with and that in doing it this way we would achieve a mesh network infrastructure that would be much stronger for its participants than something built on a purely random basis.

## The Concept



### Commons definition(\*):

The commons is terminology referring to **resources that are owned in common or shared** between or among communities populations. These resources are said to be "held in common" and **can include everything from natural resources and common land to software**. The commons **contains public property and private property**, over which people have certain traditional rights. In some areas the process by which commonly held property is transformed into private property is termed enclosure.

The commons were traditionally defined as the elements of the environment - forests, atmosphere, rivers, fisheries or grazing land - that **are shared, used and enjoyed by all**.

(\*) Wikipedia

## The Concept (II)



### Open Commons as opposed to Enclosed

Private or public property doesn't matter

Public property can be managed or used Enclosed

Private property can be Open to all

### Bottom-up Broadband

Bottom driven initiative to build Commons infrastructures and meet the Top-down

We were able to explain to them that a viable sustainable public infrastructure would need to be built in a formal way on a peer-to-peer agreement to interconnect with everyone else. We made it very clear to everyone that the best path forward would be to build on a shared peer-to-peer basis where the infrastructure would belong to and be operated by the builders and the users and where it would be kept quite independent of the ownership or control of any kind of telecommunications incumbent or network operator which in most cases was the phone company.



**COOK Report:** Your presentation talks about the network operations in the sense of occupying a Commons for the benefit of as many people as possible. Is this an example of that situation where you are talking about issues that are as much philosophical and economic as they are technical?

**Roca:** In the early days, that is to say in 2003-2004, we did not yet have this kind of vision. We were just focusing on our immediate local areas and on agreements with our neighbors and ***one thing that we soon discovered was very helpful was the ability to make an agreement with the local bishop.***

## The guifi.net initiative

### Building the Commons from the Bottom



### 100% Bottom-up Broadband

#### Goals:

#### Broadband 4 ALL

Create self-sustainable ecosystem. Any help might be appreciated as a facilitator or speed-up, however the network needs to be viable by itself, therefore:

Need to get rid from speculative interest or low value-add intermediaries

Based on organic growth

By developing new business models, enabling new stakeholders & "self-provisioned" operation

Room for innovation & cooperation by addressing today's unmet challenges

What happens? Well each Bishop has links to a number of churches and of course the churches have very good places to install antennas. We install antennas and radios in these buildings for free. We are non-profit. We work for the benefit of local populations and not for the economic benefit of any third parties.

## Taking an Expansive Point of View - Looking for Partner Building for the Commons

**COOK Report:** Did the Catholic Church support for your effort in part because you were using the idea of a commons as your foundation and the Church thought that this was a good idea?

**Roca:** Yes. As far as the Church was concerned the point is that we were building something for the community. You don't have to be Catholic to be part of guifi.net, and while Spain has become much more secularized over the last few decades ***our idea of service to the community was certainly very much embraced by the Church.***

Two things happened. We built very much for the commons and rather than focused on my city or my village wireless, our focus was much more global and we were looking to connect everyone. This was in 2003-2004 and so, instead of building just for the geeks, we decided to include everyone. Very quickly we started doing multi kilometer wireless shots between several villages and we helped everyone who was interested no matter whether he or she was a technician or not. We were looking for partners. The bishops were partners but ***we also recruited local municipalities and local administrators who were seriously looking for solutions to help the real people at this point.***

**COOK Report:** Did it make a real difference because, by 2003, people were much more aware of the kinds of opportunities that they could get with access to the net and what was becoming known as Web 2.0?

**Roca:** Yes, even then with ordinary, non-technical people, you did not have to explain very much why internet was important for their lives. If you spoke to the fathers in these rural areas, you would find out and that these men did want to give their children the same opportunity that the Internet afforded children who lived, for example, in Barcelona.

**COOK Report:** I remember writing in 2005 or 2006 about some people in the city administration in Barcelona who had plans to bring fiber into the countryside? What was that all about?

**Roca:** Well we were not visionaries. At that time we thought we would find a temporary solution that could perhaps become permanent. Government was spending multimillions of Euros on those programs – ones that we assumed would be successful. These public programs managed to connect a few thousand people in rural areas after spending a €50 million budget. By 2008 In 2008 the Catalan gov. stated that the "Banda Ample Rural (BAR)" program had connected about 8000 nodes. They did not directly state how much it cost but from other indirect sources we estimated about 70M€. Aside from that BAR uses had a monthly fee of 40€ and the Catalan gov had to pay another 40€ to the company per user per month.

By the same time [guifi.net](http://guifi.net) already had more than 8000 nodes in operation. In our case the connections were done at zero cost to the taxpayers while, given the public program, connections were made at the expense of creating a very large taxpayer liability. We demonstrated that we could do quite a lot without subsidies or the promise of any economic model based on subsidies. If you look at where the publicly funded subsidies were directed, you will find that they were sent to the incumbents – that is to the large telcos.

## Open organization

### Collaborative & social

Forum, mailing lists, social networks

Sharing resources, knowledge management, methodologies

Internet enabled applications

Network management & self-provisioning

### Horizontal, meritocratic

Focused on results

Welcomes innovation & participation

### Business friendly

Common infrastructure, but open to any service provider

## In terms of Economics

### It's all about:

Raise funding & supply

Meet more demand

Cut TCO

By introducing new business models

Balance the ecosystem from infrastructure control to providing services

Enable BuB as an option

### Doesn't break the market rules

Is about enhancing competition

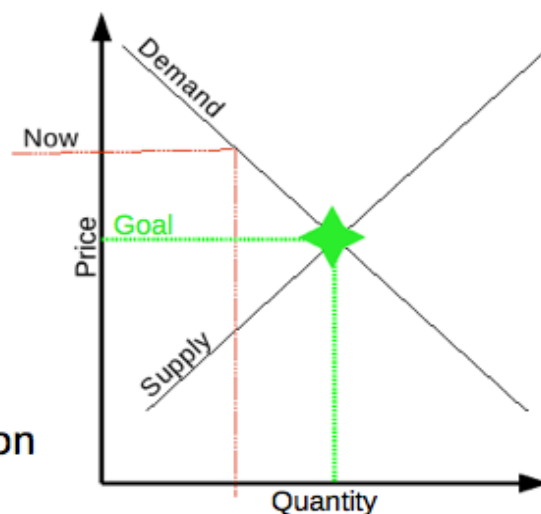

**COOK Report:** I had heard about a fiber project for Catalonia called Xarxa Oberta, sponsored by Local Ret and seven and a half years ago - summer of 2005 - I wrote about it. That 9 page article may be found on page 100 through page 108 of my September October 2005 issue [downloadable as a pdf from this page on my site.](#) At the time it looked as though Local Ret was an inspirational example of the Catalanian people, government and Telefonica coming together for the common good. [**Editor:** this specific case is discussed on **pages 74-78** below.]

## What Top Down Broadband Looked Like – Telefonica in Complete Charge

**Roca:** Would that what you were told so long ago turned out to be true. Let's look at reality.

In some cases, for example, an incumbent would win a public tender of €10 million to fiber connect a specified area of rural villages and the people would find that the incumbent winners tried to deploy a few nodes as possible because the profit was in the tender itself rather than in its exploitation by building out nodes. What the incumbent wanted was not a requirement to invest but an opportunity to increase its profit margins. Before long there were lawsuits filed by the public administration of the towns that had awarded a grant to the incumbent insisting that the incumbent had not produced what they contracted for.

Very often these public tender contracts were given to new companies who were pledged to build works that are in competition with the incumbent. But the public did not benefit. To give you one example, shortly after one contract had been awarded to a brand-new company, that company was acquired by Telefonica.

You mentioned how when you visited Spain in 1966 you were impressed by the apparent influence of the Catholic Church everywhere you went. Well I would say that in the early years of the new century, Telefonica exerted far more authority within Spain than the Catholic Church could have ever dreamt of. For example, imagine situations such as this huge company having as its employee the wife of the Prime Minister! They then lobby and get contracts like this from local public administrations. [**Editor's Note:** Public Administration within the European Union refers to local or regional government authority.] You must realize that the motivation of any big corporation like a Telefonica is to increase its quarterly income quarter after quarter after quarter. These companies are looking for increased profit margins - not for investments. Telefonica doesn't care whether it serves 10 million or 50 million customers; what it does care about is that every quarter it increases its profit margin.

In the end ***all these programs were based on subsidies and there were no real long term sustainable business models behind them.*** What they would have to do was not well specified. The approach to the government was "give me the money and I



will do it.” Also at this time in the European Union telecommunications was liberalized and Telefonica, in theory at least, was no longer a monopoly and its could say to the government you cannot do it on your own but must do it in cooperation with what we would like. We are now private sector

and under liberalization you must cooperate with us and give us the money. We took the liberalization policy at face value. And we assume for a short while that the need for what we were doing might have been fulfilled but after watching what Telefonica did, as supposed to what it said it would do, we realized that our activities were even more necessary than before. We realized now that we could not work with Telefonica without having a legal form of our own and as a result incorporated as a not for profit foundation. I am the head of the Board of Directors of that Foundation. Five of us joined the board. All five of us worked together very hard.

Also under Spanish law, when you have a foundation like this, you cannot be paid any kind of salary by the foundation. You can have employees but board members themselves cannot have any direct income from their work on behalf of the foundation.

This is why I still have my job with Oracle and all the other board members also maintain their economic independence and, as such, have no conflict of interest. I explained our role by saying that we are business developers for others and for the local employees who are providing services to their local communities on behalf of the network.

## P2P Universal Peering Agreement

COMMONS<sup>4</sup>EU  
guifi.net

### P2P Peering Agreement

- Free transit for all & single open & public Commons
- Ensures building Commons
- is not about private networks
- Enforce non-discriminatory basis
- “Network of networks” by “Comuns XOLN”
- Stakeholders retain ownership, QoS & SLA advantages
- Win-win scenario, stimulates investments
- Aggregation of networks, creating a whole and extending the Internet

## Legal framework

COMMONS<sup>4</sup>EU  
guifi.net

### EU Directives

#### General authorization (2002/20/CE)

- Everyone is entitled to develop telecoms
- NRA at every country to ensure a liberalized market
- We should notify them
- To be addressed at each member state

### Legal entity: The Operator

- Not-for-profit, Non-partisan Foundation
- Coordination – foundation for interconnection/interoperability, manageability and self provisioning
- Formal entity, becomes the formal operator

# Fiber Becomes Mandatory -- and the Importance of the guifi.net Foundation

As 2007 became 2008 we realized that our users would need to incorporate fiber optics as well because, in places, the growth of the network was demanding that. For example some of the point-to-point links on our network backbone were demanding now the capability for handling terabytes of data on a monthly basis. When you face a situation like this you will soon realize it is much more cost-effective to switch from wireless to fiber. We started buying fiber from China at about €1000 per kilometer and started to deploy it where the copper had been. If we deployed fiber where the copper had been we could cover 100 km at 1 Gb per second.



Smart citizens building commons by investing and collaborating and hacking public domains & resources.

## Traditional proprietary/closed model vs Commons BuB



	Investor	Business goal	Coverage	Service level	Competition
Proprietary Closed	Financial stakeholders or owners	Margin driven or speculative	Determined by business, not interested in low density areas or low incomers.	Provided by the operator. Often seen as a frustration by the user	Restricted to selected partners.
Commons	All participants	Participant profit driven	In the participants interest	Provided by the user, direct control if subcontracted	Open to all, including freelancers and SME.

**COOK Report:** How did you acquire the necessary rights-of-way to lay your fiber. in situations like this that often becomes a very difficult problem. How did you solve this?

**Roca:** *Our establishment as a Foundation in 2007 gave us the legal capability to act as a carrier and important other capabilities of right to interconnect with other carriers and the ability to join [RIPE NCC](#) as a full-fledged member* to get an autonomous systems number and the assignment of IPv4 blocks. We now were no longer an ad hoc backyard project but a serious full-fledged Internet service provider.

As a new Internet service provider, our business model was somewhat different and very simple. Instead of making money because you control the infrastructure, the money to stay alive comes from the services provided over the infrastructure that is a part of the public commons. **Now to make this public commons infrastructure valuable for the community that uses it you contract for service level agreements with the users where people who maintain and operate the network do upgrades and fix problems are paid by the users.** The people who operate the network and fix problems are all scattered locally across the network service area so when a problem occurs the person who fixes it is almost guaranteed to live nearby. We can point out to our customers that instead of talking to someone who may be in a Telefonica call center in Argentina: they will no longer have to wait many hours or even longer for Telefonica to send someone. [guifi.net](#) has established a cadre of people who have the necessary skills in every community.

**COOK Report:** How does it work from the customer point of view? Supposing I move into one of these villages and I want to obtain service directly from [guifi.net](#), how do I do it and what will it cost me? [This will also be examined in much more detail below.]

**Roca:** Well if you have some technical skills and want to install your own antenna and get connected, it will cost you between 200 and €300. About one third of that is material and two thirds labor. If you are actually getting fiber from a highway as a spur connection that covers about a kilometer to your farm or remote small business it would cost between about 800 and thousand euros. This would be a one-time connection cost and your monthly bill for data including voice would be about €20: and with these prizes the electronics that we buy by default to light the fiber do so at 1 Gb per second. If you decide that you really need the bandwidth you can get a symmetric service of 1 Gbs for €80 a month.: In 3 to 5 years we will very likely be able to upgrade the entire network by replacing the 1 Gb per second optronics with 10 Gb per second optronics at approximately the same price that people now pay for one gigabit. The connection to [guifi.net](#) network (specially in WiFi) is free, so if you follow the DIY approach all you pay is the equipment required to set up the links. Once in [guifi.net](#) network you have free access to basic services such as to a federated WEB proxy system that has more than 300 proxies. What has a cost is: 1) the installation itself if it is done by a professional installer (all of them are SMEs), 2) some services, like full internet access (these services are provided by local ISPs; they flow over the [guifi.net](#) network)

# 10 year perspective

guifi.net

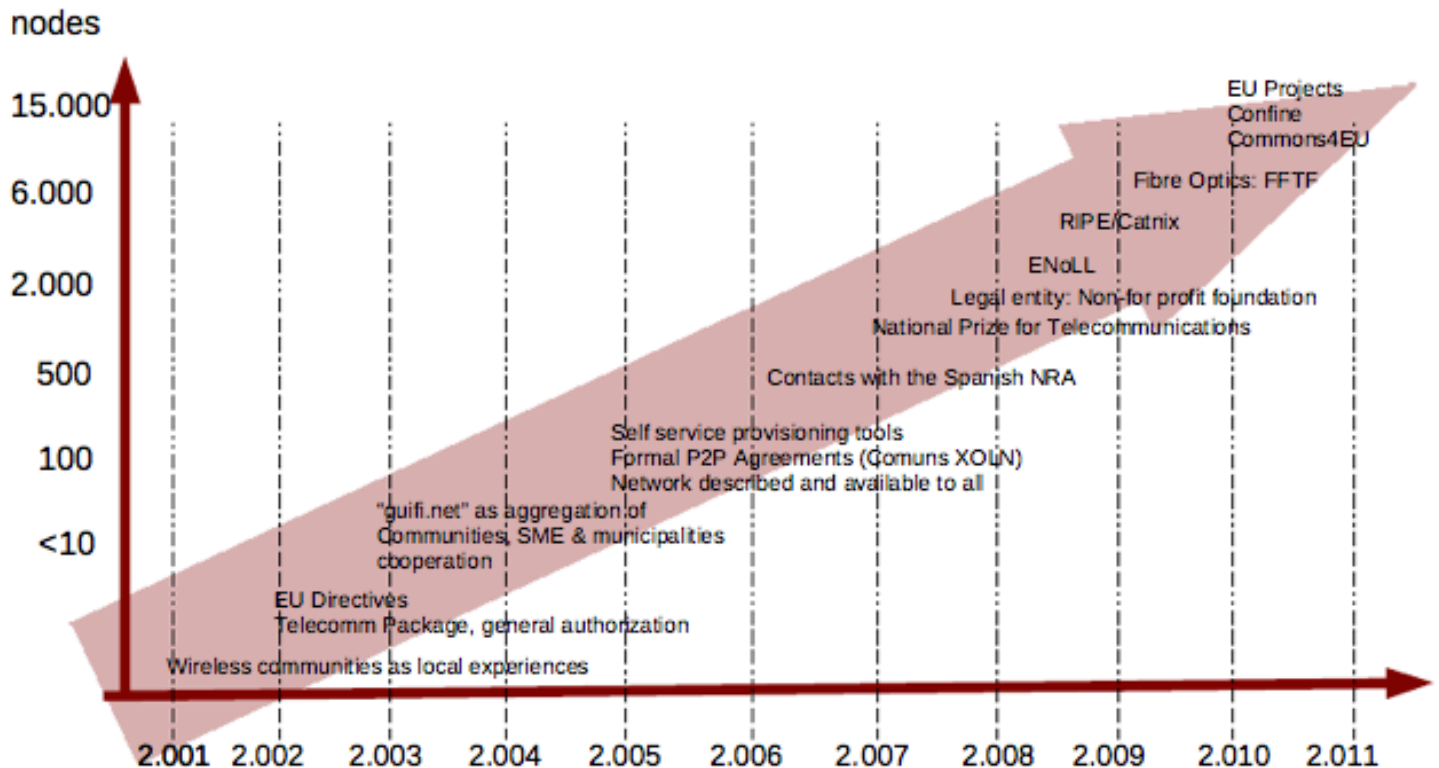

**COOK Report:** Let me ask you another question. I have the impression that you have wireless users scattered all over in small villages. However, fairly early on, you began to string fiber to connect the villages to each other. Is that correct?

**Roca:** Yes. We started the fiber **from** the rural areas and that is why we use the term FFTF (Fiber From the Farm). By next year (2013) we hope to reach our first urban areas. The speed of doing this will depend upon two variables over which we do not have too much control. However we are trying to do our very best. One of these is that we do not have too many trained professionals because indeed laying the fiber takes some professional training. The other difficulty is the fact that the incumbent providers, primarily Telefonica, try to protect their incumbency by making it difficult for us to expand. We are creating competition for them and they do not like that one little bit.

For example the installation of a last mile network extension of a few kilometers in 2009 took us about 9 weeks to get the necessary permits and build the entire extension. Now when you go from the last mile for a few kilometers and you'll eventually reach the existence of potentially available dark fiber into which you could connect and easily then go all the way to Barcelona and the undersea cables that attach Barcelona to the rest of the world instead of being connected quickly you are slowed down by the reluctance of the incumbents to permit you to interconnect. You now run into problems with the law which



after liberalization is supposed to be non-discriminatory, equal opportunity and a bunch of other good things -- you suddenly find out that reality is quite different from theory.

When you want to make a specific connection to someone else's fiber that other party gives you excuse after excuse as to why it is too difficult doing everything it can to slow you down. As you can see from the chart on the next page NRA is Spanish Regulatory Administration. In every country of the European Union there is a national regulatory agency.

**COOK Report:** In selling your case in talking to the Spanish NRA you were trying to figure out how you and Telefonica would enter act in dealings with each other? And your foundation was established in 2007?

**Roca:** Yes to both of your questions, and ENoLL is the [European Network of Living Labs](#). This is built on the assumption that the most fertile innovation comes when there is a joint venture between political administrations, universities, companies, and real users. At one point, on behalf of the European Union, there was an accreditation process to recognize organizations that were using this approach to work with each other on behalf of innovation. We obtained certification from them because we were a very good example of innovation driven by our users.

**COOK Report:** And in 2007 you joined RIPE NCC and [Catnix](#). RIPE NCC is the European IP Address Registry and I would imagine Catnix would be the Catalonia Internet exchange in Barcelona and your source of connectivity not only to all of Spain but to the global internet?

**Roca:** That is correct. This is our source of peering and interconnection.

**COOK Report:** In 2007, when guifi.net obtained its first legal recognition, how did you do back haul at that point? From the point of view area how did the network grow from year to year? Do you have any maps?

**Roca:** Yes. [They will be shown in detail below.] As we began to grow, ***we had to develop the software kinds of tools to deal with and manage the growth such that our network could scale and we needed the involvement of other professionals to achieve this***. Also these tools were needed to manage the distribution of IPv4 addresses. All of this requires an extensive software development effort. Consequently on the backend of guifi.net there is a database. As part of this there are engines that manage IPv4 addresses and create configurations to manage such critical backend tasks as BGP configuration peering, SNMP configuration and so on. To give you an example, if you go to our guifi.net website, you will notice in the middle of the page a chart depicting the number of working nodes. This number comes directly from the database and every time a new node joins the network and becomes active whether it be on the basis of an installation by a 3<sup>rd</sup> party or a self-service installation. The growth in the network is measured automatically.

**COOK Report:** This is excellent but where would I go on the website to get instructions assuming I live in the region and wanted to join the network on how to sign up.

**Roca:** At this point you cannot unfortunately. We have tried many times to create this page, but have not yet managed to do it. You click on the button to the right "get involved" and the page that one day will be there so far is not what you must do is go to a local meeting.

You will find that these local meetings are quite frequent. Imagine that you are living in an area and you want to be the first in that area to be connected. Unfortunately you can do nothing. You must find someone who is connected and is also close enough to you to connect to.

**COOK Report:** How would I find out where the next meeting was in an area reasonably close to me that I could attend?

The screenshot shows the Guifi.net homepage. At the top, there is a navigation menu with links for 'Informació', 'Support', 'Foundation', 'Contact', 'Press', and 'Login / Register'. A search bar and a language selector (set to English) are also present. The main banner features the 'guifi.net' logo and the tagline 'Open, Free and Neutral Network Internet for everybody'. Below the banner is a large heading: 'Guifi.net, a project for everybody' with a subtext: 'Individuals, companies, administrations... they have made their lives easier thanks to Guifi.net'. Three main content boxes are displayed: 'What is guifi.net?', 'Experiences', and 'Get involved!'. Below these is a statistics section titled 'GUIFI.NET TODAY' with sub-sections for 'SERVICES', 'RECENT POSTS', and 'NEW FORUM TOPICS'. The statistics show '19159 working nodes' and include a list of metrics: 22144 links, 34680.2999999999 total kilometers of links, 153 last week new nodes, and 50 working nodes last week. A line graph titled 'Nodos operat.Ivos' shows an upward trend in active nodes from 2004 to 2012. To the right, there are sections for 'Guifi.net Foundation' and 'Sponsorships'. At the bottom, a row of logos for sponsors like RIPE, operspectrum.es, and CATVIX is shown. The footer contains a grid of links for 'Informació de guifi.net', 'Eines de gestió', 'Support', and 'Reconeixements'.



## Understanding How guifi.net Has Grown

**Roca:** Okay, but let me first show you the map that explains how the network has been growing. Here you will see a map for the [entire region](#), where Barcelona on the coast of the Mediterranean Sea is right in the middle.

We do have the means of showing growth. [This page starts](#) with a satellite view and you will see on the upper right there are some buttons and if you click the one called "init" for initiate you will, in effect, tell the database to play out the locations of the nodes as they



have joined the network from the year 2004. Now you can get a better idea of where the network is laid out by going to the map view and you will see that it has grown mainly but not entirely along three North, South highways extending from the major highway E 15





that goes inland and somewhat parallel to the Catalonian coast - namely C16, C17, and where E15 turns northward. [Editor: as readers will see, it turns out that for people well motivated enough to study the website in depth can find out how to join.]

27/03/2007 nodes: 1162





18/02/2008 nodes: 2766



23/01/2010 nodes: 7432

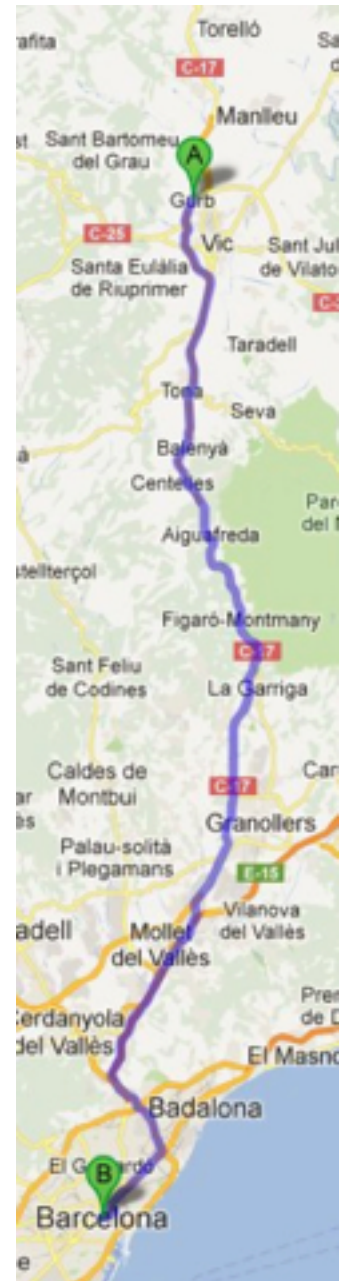

Above is Ramon's route from Barcelona to Gurb. From 2009 to the present as will be shown in the next section they have been installing fiber from the farms to the C17 expressway.



10/12/2012 nodes: 13920



The growth is organic which means that when we reach a new town, people in the next town are aware and began their efforts to link their newcomers to folks in the previous town.

### GURB Nord Project Phase 1 2009

At a cost of 18,000 euros the residents “crowd-Sourced” this fiber. In a March 2012 [Tedx Madrid program](#) Ramon described the citizen’s build. They laid areal fiber and the ran it down the main street of Gurb and after two years got permission to connect to the fiber running along C17. Pictures continue on next page.

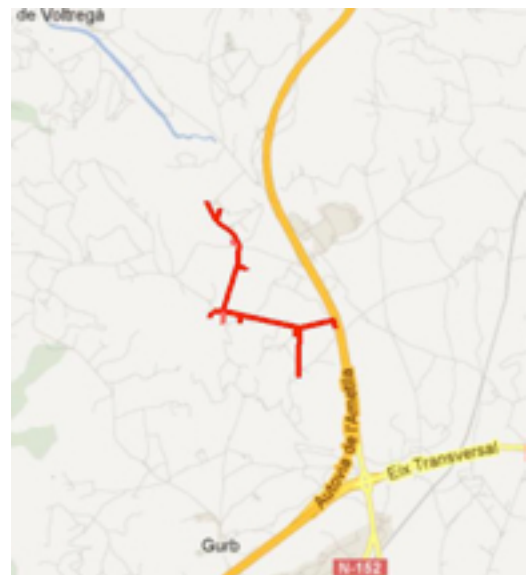





Fiber jumps the road on poles and runs on main street to the high way.

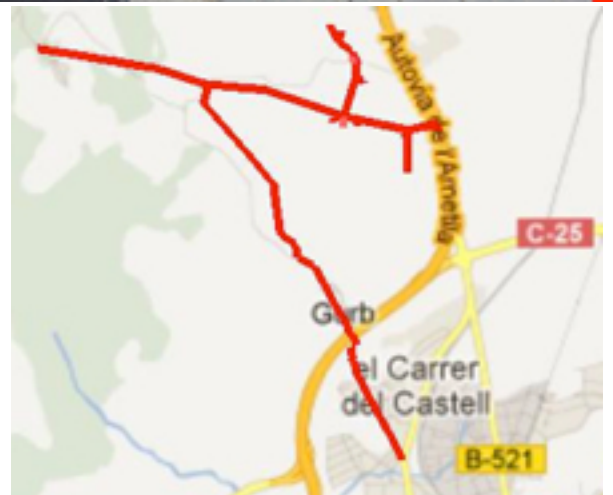

Phase 2 on the far right was completed in late 2011 and.....

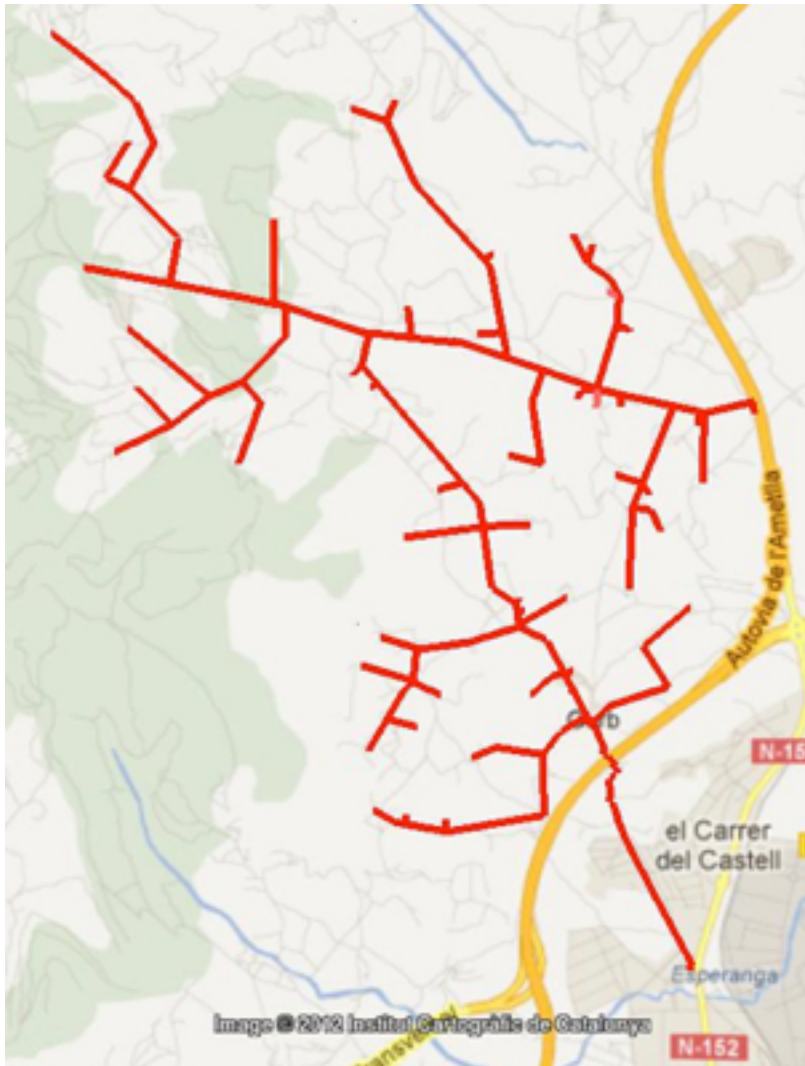

Phase 3 in 2012 and a more dense loop of country road N-152 in late 2012. The phase 4 picture below attaches to the lower right of the phase 4 picture to the left.



Phase 2 cost 40,000 euros, phase 3 and 4 400,000 euros and in 2013 a trunk along C-17 north from Gurb to St. Pere de Torelló 30,000 more. Road N152 crosses B521 at el Carrer del Castell above right. This is in a suburb of [Vic a city of 40,000](#) an old historical city just south of Gurb. It is situated at a possible jumping of point for the fiberization of Vic

On the preceding page (p. 47) we get another example of the depth and richness of the information on the guifi.net site. An aerial view of the fiber node, yellow for fiber, green for radio links and red for the fiber breakouts. It is shown followed by an extremely detailed blog tutorial used to explain the installation. This is the url <http://guifi.net/node/23288>.





## Description of the first section of fiber in Gurb (FFTF)

created: Dc, 29/07/2009 - 15:43 - Ganon - modified: 06/03/2011 - 12:48 am

Here's a brief description of the project we are preparing to make the first connections from Farms with Fiber Optic (FFTF) in the municipality of Gurb. 1 Gigabit connections are replaced and some sections are now wireless.

### Proposed action Summary

- Municipality: Gurb
- Terms and conditions of the network: Free and Open Network Neutral based interconnection agreement between equals " [Pro-Common open, free and Neutral "XOLN "](#)
- Features deployment
  - 2 kilometers of [fiber optic trunk](#) open and neutral format, capable of bleeding (fiber connection) along the entire route.
  - 3 finished fiber connections to homes / farms / farm with a fiber indented from the " [Corca](#) "with" [torpedo](#) "and ended with a switch with 8 UTP connections, 2 [SFP connectors](#) 1 Gbit fiber connected to the fiber and mounted on a [wall closet "rack"](#) 10 "6U. In total is expected to initially give connection to 3 houses, provide connectivity options for nine houses, and start on some sections that can be expanded in 12 additional homes (in short, a performance that may affect up to about 24 homes, farms or farms or live-stock). The incorporation of new connections will gradually go away as checking the proper functioning.
  - 6 "[kinks](#)" to make connections to more homes and new branches.
  - Mainly air, using the sticks of copper telephone line existing facade where needed, and perhaps a stretch buried.
  - Ability to support a bandwidth of 100 Mb / s (megabits per second), higher 1Gb/so.
  - Forecast interconnection with other networks promoted by the government open.
- Planned implementation: Immediate

### Details and features of the deployment Fiber Optic Cable

For distribution trunk cable is used suitable for outdoor installation and protection of polyethylene dielectric (non-conductive) with 80 fibers, so as to allow bleeding of making one or more fibers in each connection point, while lengthening the leg up in the future can be completed rings.



The features are:

- 8 tubes with fibers 10 each (total 80 fibers).
- 15.4 mm diameter
- 125 m in length between poles
- 175 kg / km (17.5 kg/100m)
- Tensile strength of 4000N
- Crushing Strength 2500N/100mm

### Attachments to the sticks

The aerial cable is attached to the poles with a hose fittings catching with a skirt to not stress him, and hung the stick from a stainless steel clamp.

### "Torpedoes"

The "torpedoes" are capsules that serve to order the cable to which you have removed the protective outer layers and are left bare to make connections or welds. The cable is coiled inside commands in "cassettes". On the right you can see diagrams of these capsules, and below, images of different types of "torpedoes" and its components.



Are expected to mount a "torpedo" at each point where there will be a bleed connection to a house or fibers branching, or a welding operation. [Editor's note there is another page of detail that I have not included.]



- Building a complete end to end solution for NGN networks**

When Where		Milestone	Status
Feb-Mar'09	n/a	Notification to ANR (Spain: CMT)	done
Apr-Jun'09	Rural last mile	Project definition & preparation	done
Jul-Aug'09	Rural last mile	Network deployment	done
Jun-Dec'09	City	Membership RIPE & Local IX (for wholesale)	done
Dec'09	Rural last mile	Network operational (between farms)	done
Jan-Jul'10	Regional link	Negotiations with authorities, public administrations...	done
Aug-Nov'10	Regional link	Project definition & preparation	done
Dec'10	Regional link	Connection works (fiber fusions)	done
2011	All	Full operation FFTF <---> Internet	done

Above is a time line for the details of the Gurb fiber build out just discussed on the previous four and one half pages. Below is the [home page](#) for Xarxaoberta the regional fiber network built between 2002-2006 by the public administrations of Catalonia and already discussed. The small map just below gives an idea of where the fiber of Xarxaoberta runs.



**Joining guifi.net in Three Steps [\(click here\)](#)**

And you will find instructions on how to join should you be living in the general area of the network.

## Joining guifi.net in three steps

created: Sat, 01/10/2005 - 21:34 - lluis.dalmau - updated: 17/11/2011 - 12:02 pm

This guide t'adjudarà understand what guifi.net project, you can also contact other members of the network. It is a guide for yourself you can do the installation, or you can choose any installer to get it done.

It is recommended that you look at the guidelines and / or courses to see how the three steps and other interesting things:

- manual on how to mount a node (PDF) (AleixRoca, 07-2010)
- extensive guide assembly step of a supernode (acacha, 03-2009)
- video of the whole process (Henry, 22-10-2008)
- Guide reusing old routers (JaumeSala)
- guifi.net manual connection (PDF, 7.8Mb) (V5 carles\_se 13-03-2010)
- Example step connection to a specific supernodes (Institut de l'Ebre) (acacha 17/11/2011)

For questions on the steps you can write to the mailing list guifi.net or forum but is **very important** for you to say the **name of your node** and **the web link** that takes, for example:

I'm adding a device ... .. **VicCasaMeva** <http://guifi.net/ca/node/1714> to me and this happens ...

It is recommended that you read the documents that contain:

- General Principles of deployment guifi.net
- Code of Good Practice

The **basic equipment** that a user may need this

The basic steps you must follow are only 3 or so but some extra dedication begins:

1. **Add a node**
2. **Add a new device**
3. **Add a link**

### Step 1. Adding a node

understand node as the place where you want to join a stable and permanent guifi.net

Need:

- put a name to the node

example VicDrFleming21 or BCNsepulveda111

**Recommended:** use the name of the town, at first, tries to respect and abbreviations have other nodes in your district, if any, in the end, put the name of the node

- Add your node

First you need a website user [www.guifi.net](http://www.guifi.net) and have logged in as a registered user

add a new node:

- use maps

## Documentation guifi.net

- ▽ Introduction to guifi.net
  - ▽ Joining guifi.net in three steps
    - Distances and profiles
    - What I put my router firmware?
    - The creation of users for "proxy"
  - ▷ How do you open, free and neutral guifi.net?
  - ▷ Presentations
  - ▷ Collection of guides and manuals
  - ▷ Questions and Answers guifi.net
- ▷ guifi.net background
- ▷ Collaborate with guifi.net
- ▷ Business partners, service companies, installers, shops material ...
- ▷ Development
  - How to translate the menus on the website Guifi.net
  - Budget
  - ▷ On the common wireless license

**COOK Report:** I found these instructions in Catalan almost by accident on the website while I was [looking to make the maps shown above](#). This illustration is produced by using Google translate. Click here for the original version in [Catalan](#). Or better yet under idiomes (languages) at top click English and you get this different [illustration](#).

## 1. 2. 3. join guifi.net !

created: Sat, 26/02/2011 - 17:22 — lluis.dalmau - updated: 07/11/2012 - 12:28pm

There is coordination and help forum: <http://guifi.net/en/forum/228>

If you are interested in some document without translation, you can use an online translator or ask for help in the forum.

You can join guifi.net in three steps ...

1. **Add a node**
2. **Add a router in your node**
3. **Make a link between your router and an access point near your node**

### Step 1. Add a node

A node is a location, for example, your house. A node is a stable place of guifi.net

You need ...

- a user of this website
- login in guifi.net with your user
- add your new node ...
  - o use the map
  - o or use guifi.net zones [http://guifi.net/en/guifi\\_zones](http://guifi.net/en/guifi_zones), make zooms, find your location and clic on the map for add your node

Remember ...

- o node name, it's interesting ... CityStreetNumber, for example: VicDrFleming21 or BCNsepulveda111
- o short name, it's your node name, for example: VicDrFleming21 o BCNsepulveda111
- o coordinates, latitude and longitude
- o other information ...

Un cop hauràs desat ja tindràs el node afegit i podràs començar el segon pas ...

Now, you have different tools available ... Distances from your node

### Step 2. Add a router in your node

In your node page, you can add a router, for example, '*Trasto sensefils, com ara un router o un punt d'accés*', Router Wi-Fi like a router or an access point

Select this option, add a router, filled form and save your router information. It's important to select your router correct firmware.

Normally, you need to add a 'wireles radio' in the form.

### Step 3. Make a link between your router and an access point near your node

You've added a node, congratulations!

You've added a router in your node with a 'wireless radio client', fantastic!

Now, you need to add a link between your 'wireless radio client' and an access point near your node, come on!

- if you have an access point near you, you're lucky!
- if you don't have an access point near, you need to coordinate with the people in your area, for example, use the forum, talk with the owners of the other nodes, convince your relatives or friends to set up a node, ...
  
- Your router is in your node page in guifi.net
- edit it!
- you can choose to add a link to an access point, select it!
- find and choose the correct access point
- save the form

Now you have finished work on the web and you can download the configuration file 'UnSolClic', there is information in the configuration file for configure your router.

### Add a new area in guifi.net website

If you don't have any guifi.net node in your area, you can write to the forum and we can help you for add your new area.

See you soon !!!

///

These excerpted instructions are more brief and appear to be written for more for English speakers than the translated Catalan page that precedes them. The [Catalan page](#) is extremely rich with links (not visible in the screen shot above) to [YouTube tutorials](#), general videos, and system documentation.

It is extraordinarily interesting to see how the members of the guifi.net community have been able to map out and compile what it takes to join the network in such a way that others can join themselves to the network with a minimal amount of effort. It appears that they have a situation now where joining the network can effectively become self-provisioning. This is the only network of its type in the world of which I am aware.



# Use of Google Maps for Virtual Network Planning

Guifi.net has made the most superb use of Google Earth that I have ever seen. When you want to find guifi.net nodes you bore down [from here](#).



Zoom out and you get the entire world. Zoom in and you may focus on Europe and then the Iberian peninsula. I will use the next few pages to demonstrate how the maps find zones which are built out independently of each other - with each node connecting in mesh fashion bottom up. The reader should take what follows as a guifi.net geography lesson.

Next let's go from the world map to the [Iberian Peninsula](#).

On the next page immediately to the left is a [chart](#) listing the number of nodes on the Iberian Peninsula - operational nodes in green planned in blue. **Ramon** explained: We are building in many places across the Iberian Peninsula also in Europe and in other places in the world. This is why earlier





Nom de la zona	Operatiu	Projectat
Andalucía	13	141
Aragón	35	50
Asturies	43	105
Cantabria	8	14
Castilla la Mancha	0	17
Castilla y León	10	36
Catalunya	14.856	6.849
Ciudades Autónomas	0	0
Comunidad de Madrid	27	231
Distrito do Braga	0	1
Distrito do Porto	2	1
Euskal Herria	25	52
Extremadura	2	8
Galiza	73	329
Illes Balears	2	46
La Rioja	98	34
Murcia	0	8
Nafarroa	12	17
Pais Valencià	4.074	1.833
	19.280	9.772

today I had a videoconference with people in Bogota Colombia. There is a group that has sprung up there that is going to use our methods and software and I made myself available to answer their questions.

**COOK Report:** So if I'm someone like Isaac Wilder for example in Kansas City and I wanted to use your software stack it is there for the taking, correct? Your philosophy is to make the stack available to everyone so that they can profit what from what you have done?

**Roca:** Yes absolutely. Like any other open source project we have mailing lists for the developers so by all means suggest to Isaac that he check out our mailing lists and use an appropriate one to

find out how to borrow the software that would suit his purpose. If you go [to this page](#), you will get the following page [Guifi.net World Page](#) that informs you:

“This is the root page of the guifi.net mesh network. From here you can drill down to obtain any detail of the [network nodes](#) and [services](#).” The final sentence the extract above says: “If you wish to join guifi.net network and extend this root zone, just do it: This has been built on open source and supports multi-language.” The only problem may be that since we originated in Catalonia the dominant language of the mailing lists is not only not English nor Spanish, but Catalan.

### zone information

zone name	World - guifi.net <b>World</b>
default proxy	Take from parents
default graph server	Take from parents
network global information:	
Mode	infrastructure
DNS Servers	
NTP Servers	
OSPF zone	
Time zone	(GMT+01:00) Gurb, France, Germany, Italy

### contact information

created by: rroca at 15/01/2006 - 6:05pm - updated by: joseba at Sun, 23/05/2010 - 01:44

zone statistics

### Nodes listed at guifi.net World

Zone name	Online	Planned	Building	Testing	Total
Africa	0	17	0	5	22
America	5	83	2	2	92
Asia	0	5	0	0	5
Europe	19.280	9.806	372	530	30.098
	19.285	9.911	374	537	30.217

**COOK Report:** So the growth spreads geographically in a way similar to that experienced by [Matt Larson and his Vistabeam network](#) in western Nebraska where as soon as possible when a new town is added the next town along the line of growth sees the possibility of



connecting. However, the difference here is that the connection possibility depends on Vistabeam investing in money to add a new tower and a new link and people who want service half to purchase it from Vistabeam. With guifi.net the situation is somewhat flatter and more organic in this sense that the network is more open and people have instructions available to them on what to do to become a part of the network, although once they do join the network service is not free. Neither in the case of Vistabeam nor in the case of guifi.net.

**Roca:** That is correct and the growth is mainly by contact and direct connection to what is already there. It is a bit more difficult to start fresh in the place with no existing nodes to connect to -- although it is possible to do that. Since the access to the network is open and free and the basic services (namely WEB access) are also free. It is a bit more intricate. [guifi.net](http://guifi.net) concerns stop at network level, so contents are left untouched from the philosophical/conceptual point of view. But, since networks are useless without user provided content and since we understand that WEB access is an essential right, we also spend some effort encouraging the users to add content to the network and do so in an open fashion, where the federated proxies system is the most relevant one. But again, strictly speaking, the [guifi.net](http://guifi.net) role (and therefore also the Foundation's one) is restricted to the network level.

## Growth in the Valencia Region

**COOK Report:** The maps appearing [above](#) are composed of screenshots that I took in mid-December 2012 as I am writing this material and they list the total of active nodes as slightly more than 14,000 but the guifi.net site claims a total of over 19,000 nodes. Where did those come from?

**Roca:** We think that this growth by daisy-chained direct contact is good but that we also need to emphasize our spread by working on the startup of new nodes not connected directly to each other. That is how you would account for this additional 5000 or so nodes spread elsewhere in the Iberian Peninsula. In Castile and in Valencia for example, as the map on the







previous and on the next two pages shows, it seems that we are in the earlier stages of Catalanian kinds of growth.

The next map to the left zooms in on the bottom half of the map on the preceding page.

Continuing to zoom further in and again

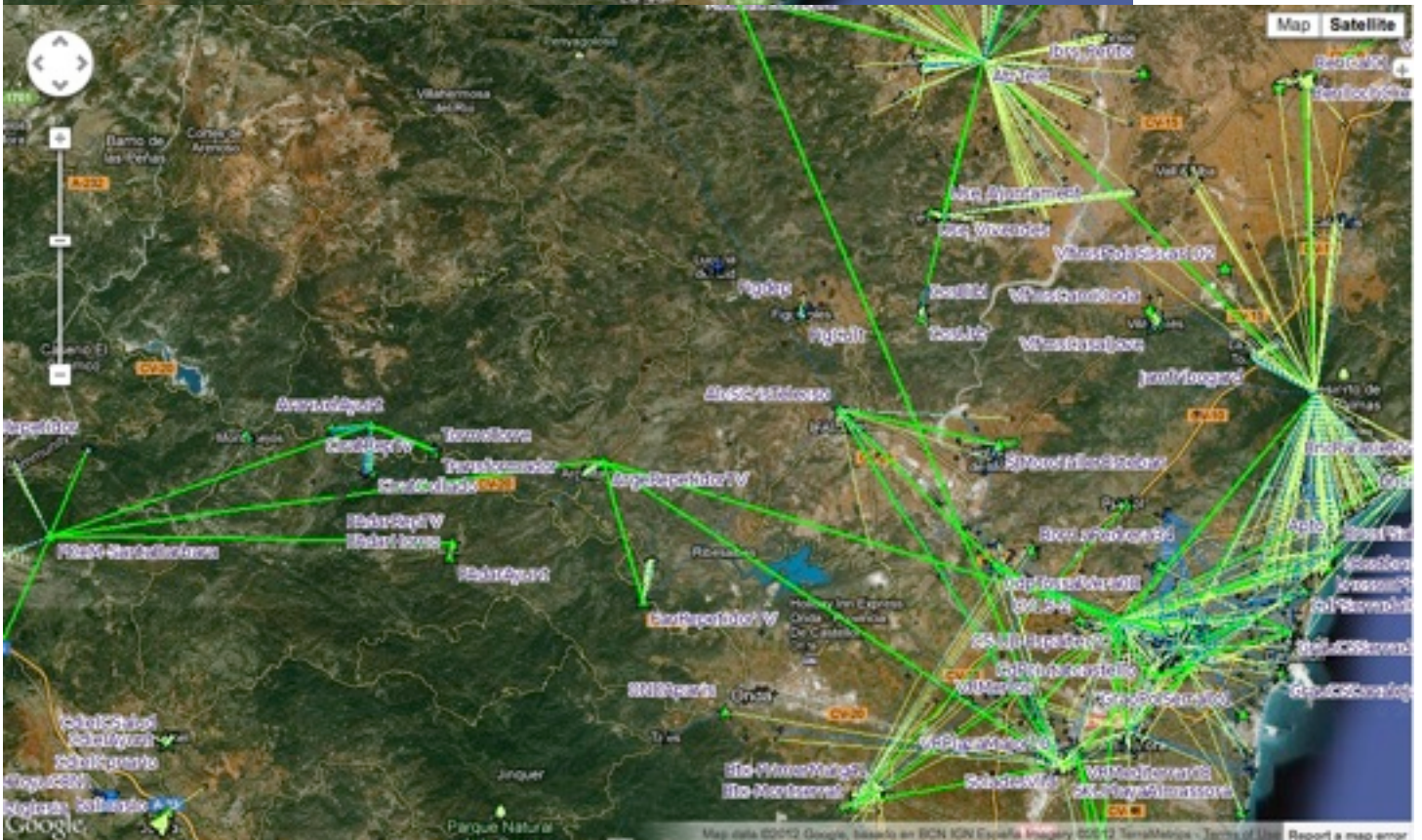





zoom in, and, as you will see several pages below, you get to the level of individual houses.

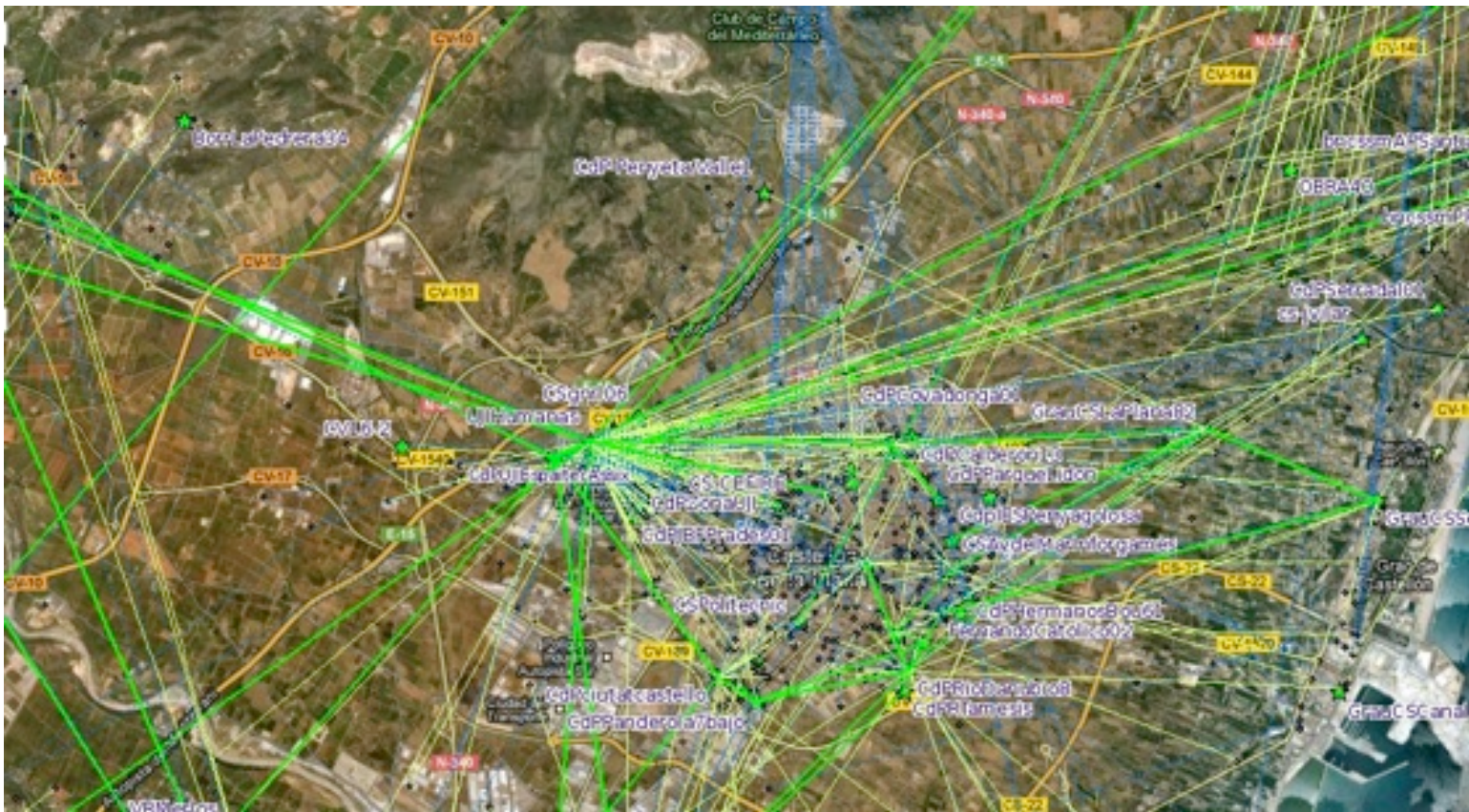



## Local Groups

Guifi.net is divided into local groups or zones that are mainly geographically organized as they build, maintain and operate their local infrastructure. Below is the [group web page](#) that offer links to the pages of each group.

created: Mon, 11/04/2011 - 22:00 — lluis.dalmau - updated: 23/12/2012 - 3:10am

In guifi.net thousands of people involved in open networks are organized globally in the mailing lists of users, but also at the level of local groups on mailing lists or websites of areas. It is important for people to get involved in local groups in order to have information on activities, incidents, improvements and any coordination to ensure and improve maintenance and availability of network and content that are available and used in a common way and for the latest news or new content.

List of various local groups

	<a href="http://osona.guifi.net">http://osona.guifi.net</a>
	<a href="http://terresdelebre.guifi.net">http://terresdelebre.guifi.net</a>
	<a href="http://castello.guifi.net">http://castello.guifi.net</a>
	<a href="http://www.badalonawireless.net">http://www.badalonawireless.net</a>
	<a href="http://www.hospitaletwireless.org">http://www.hospitaletwireless.org</a>
	<a href="http://www.guifiraval.net">http://www.guifiraval.net</a>
	<a href="http://www.matarowireless.net">http://www.matarowireless.net</a>
 pinedasensefils.cat Xarxa sense fils guifi-net a Pineda de Mar	<a href="http://pinedasensefils.cat/">http://pinedasensefils.cat/</a>
	<a href="http://taradell.guifi.net">http://taradell.guifi.net</a>
	<a href="http://digicapecapellades.net/webdrupal">http://digicapecapellades.net/webdrupal</a>
	<a href="http://cerdanyola.guifi.net/">http://cerdanyola.guifi.net/</a>
	<a href="http://www.iglu.cat/">http://www.iglu.cat/</a>

Comunidad WiFi Sillanet	<a href="http://www.sillanet.org">http://www.sillanet.org</a>
 palafrugell.guifi.net	<a href="http://palafrugell.guifi.net">http://palafrugell.guifi.net</a>
guifi.net Madrid	<a href="http://madrid.guifi.net">http://madrid.guifi.net</a>
 guifibages	<a href="http://guifibages.cat">http://guifibages.cat</a>
 guifi-net Terrassa	<a href="http://terrassa.guifi.net">http://terrassa.guifi.net</a>
Comunitat...  GraciaSensefils.net ..fent xarxa!	<a href="http://graciasensefils.net/">http://graciasensefils.net/</a> - <a href="http://guifi.net/gsf">http://guifi.net/gsf</a>
 XaTeGi Associació de les Terres Gironines	<a href="http://girona.guifi.net">girona.guifi.net</a>
 guifi-net grup local de Girona	<a href="http://guifi.dyndns.info">http://guifi.dyndns.info</a> Girona
 sensefils.net	<a href="http://PoblenouSenseFils.Net">PoblenouSenseFils.Net</a>
 valencia.guifi.net	<a href="http://valencia.guifi.net">http://valencia.guifi.net</a>
 Malaga guifi-net	<a href="http://malaga.guifi.net/">http://malaga.guifi.net/</a>
GuifiurG Grup de guifaires de l'Urgell (i esperem que de Lleida)	<a href="http://guifi.net/urgell_info">http://guifi.net/urgell_info</a> (temporal)
 HLV HackLab Valls	<a href="http://hacklabvalls.org/guifinet">http://hacklabvalls.org/guifinet</a>
 guifi-net	<a href="http://galicia.guifi.net">http://galicia.guifi.net</a>
 guifi-net	<a href="http://sfeldc.guifi.net">http://sfeldc.guifi.net</a>
Associació Guifi.net de Sant Feliu de Codines	



**Guifi.net gets considerable support from local church bell towers and roof tops for placing its antennas.**

**COOK Report:** Well how about the software itself? What language is it written in?

## Gurb Zone

**Roca:** The network software should be understandable in what ever programming language it was written, the localization of the software from Catalonia to the American Midwest for example should be easier than writing it from scratch. GoogleMaps will work anywhere but now let me show you some additional tools. Try [this URL](#) .

Gurb is the small town where I live. On the next page you see the map of the area with the nodes and their links and below the map are the supernodes shown and immediately below them but not in the above screenshot are the ordinary nodes in this area. Now move the slider on the map until you get to a level of detail where you can identify individual hubs.

## Gurb

availability   data   map   networks   nodes   pending/review   services  
suppliers   users queue

Gurb és un municipi amb força extensió (52 qms. quadrats) i dispersió de la població en cases de pagès. La majoria d'aquest territori no disposa avui en dia de'accés a banda ample de tipus comercial tot i les diverses iniciatives que hi hagut en aquest sentit. Segurament per això que a Gurb des de mitjans del 2.004 hi ha hagut una notable embranzida on els veïns interessats s'han anat organitzant fent un desplegament per donar cobertura sistemàtica a totes les parròquies (Sant Andreu, Vespella, Granollers i St. Julià) i de les zones urbanes més properes a Vic, donant així un accés alternatiu a llocs on ni tansols hi havia telèfon convencional. L'Ajuntament des d'un principi ha donat suport a aquesta iniciativa dels veïns, connectant-se a la xarxa. En aquesta zona podeu vere com progressen les connexions.







zone information

zone name	Gurb - <b>Gurb</b>
default proxy	2619-Gurb, GurbProxyEsperanca
default graph server	6833-Gurb, GraphCecilia
network global information:	
Mode	Infrastructure
DNS Servers	10.138.0.2
NTP Servers	10.138.0.2
OSPF zone	
Time zone	(GMT+01:00) Gurb, France, Germany, Italy

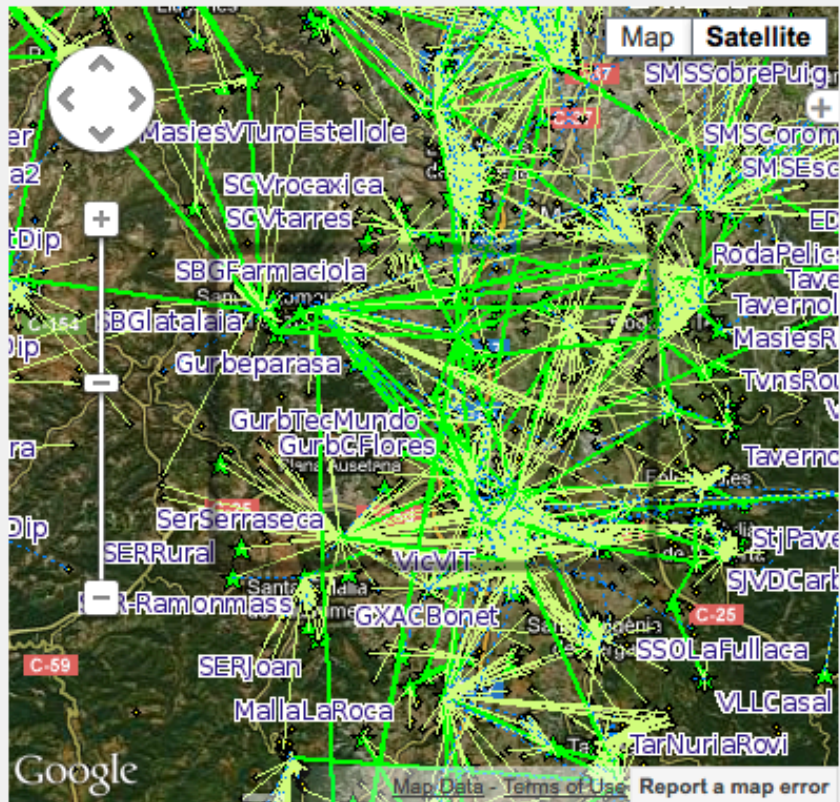

contact information

created by: webmestre at 01/08/2005 - 10:10pm · updated by:  
vicmartirs at Sat, 20/11/2010 - 15:31

▶ zone statistics

Nodes listed at Gurb

nick (shortname)	supernode	area	status
GurbCEPA	17	Amistat	Working
GurbElSerrat	17	Gurb-Nord	Working
GurbPavello	7	Sant Andreu	Working
GurbTecMundo	5	Casa Mundó S/N	Working
GurbAdelaida	4	Costat del Rest. El moli	Working
GurbCampo	4	Granollers	Working
GurbXiob	4		Working
GurbElSeri	3	Gurb-Nord	Working
GurbSEsteve	3	Sant Esteve de Granollers	Working
GurbTecCirera	3	Mas Cirera S/N	Working



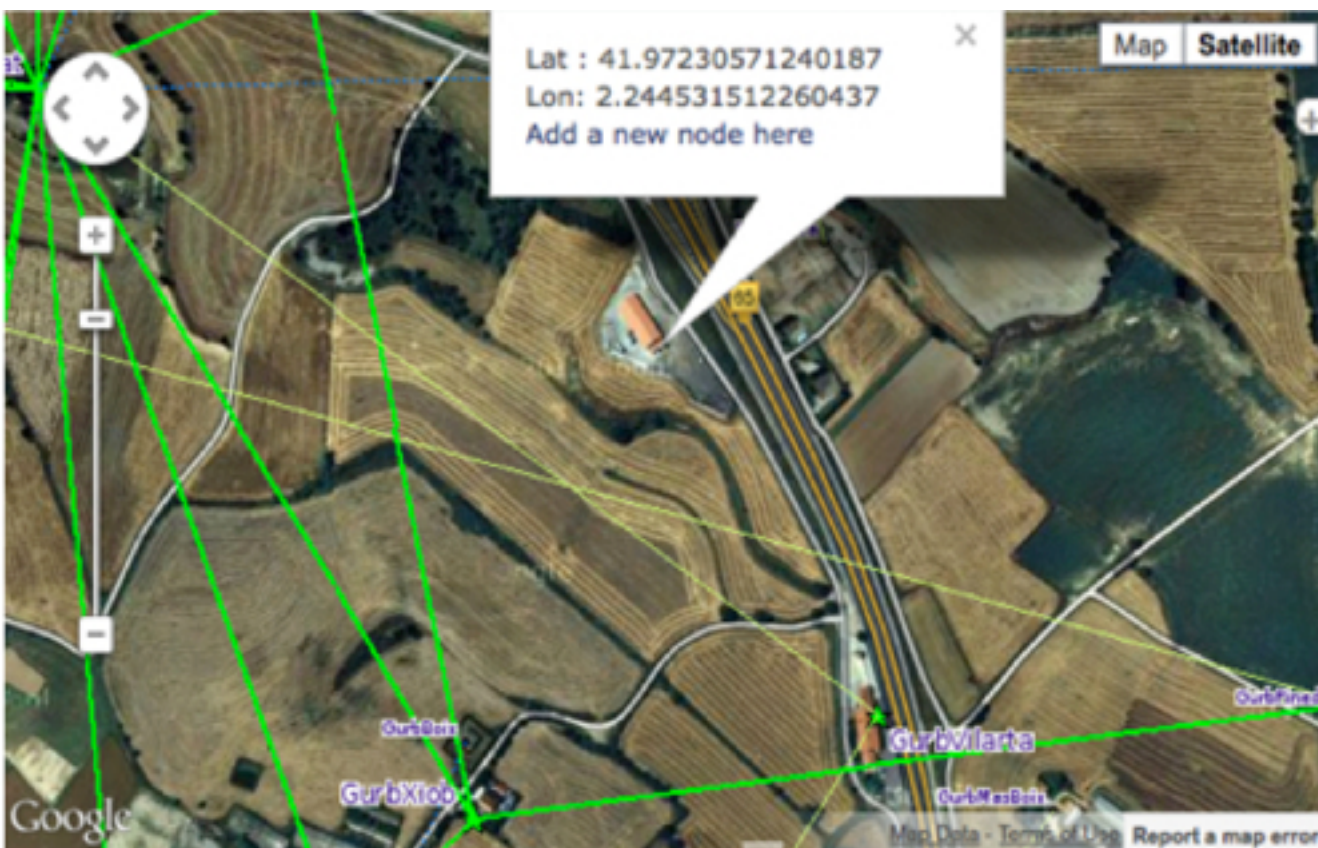

The words **"Add a new node here"** on the previous page if shown on your screen are a live url rather than as a screen shot as I have pasted in here. Click on the screen of your laptop you will get a new box asking you to fill in all the necessary forms: which kind of hardware you are going to install and what you are getting connected with. Finally the software will tell you from the precise point you have chosen whether you have line of sight to create a new wireless link from that spot. **Now, by using Google maps and this technique you can apply our tools to building new wireless networks anywhere in the world.**

### GurbTecMundo

data **devices** distances graphs links profiles map services

users

created: Mon, 07/11/2011 - 17:46 — marc.mundo - updated: 22/12/2012 - 11:39am

node	43320 GurbTecMundo	<b>GurbTecMundo</b>
zone (mode)	Gurb (Infrastructure)	Casa Mundo S/N
position (lat/lon)	Lat:41.960160 Lon:2.230321	10 meters above the ground
available for mesh & status	Yes	<b>Working</b>
graphs provided from	6833-Gurb, GraphCecilia	

**contact information**

created by: marc.mundo at 07/11/2011 - 5:46pm -  
updated by: GurbTec at Sat, 03/03/2012 - 22:56

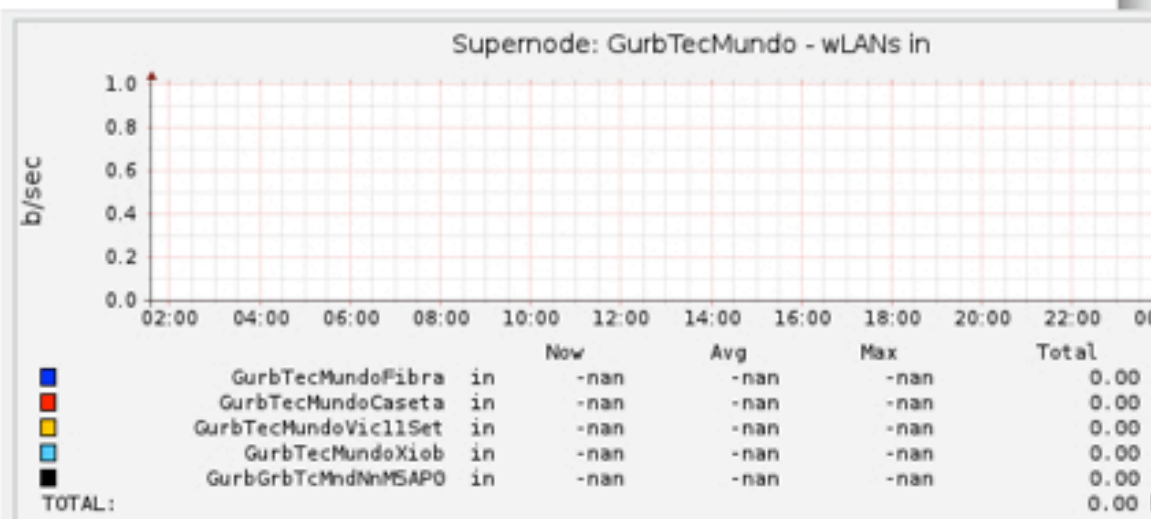



**COOK Report:** Absolutely awesome! Now I see a node called GurbTechMundo. Below the satellite view map -- on page 64 above -- is a listing of supernodes.

**Roca:** Yes

**COOK Report:** And the yellow line?

**Roca:** The yellow line is a direct connection to end users. Now the Gurbtechmundo supernode on the page above is in effect a backbone node for fixed regional connections. Below you will find CEPA the largest supernode in Gurb.

### Gurb CEPA

[data](#)
[devices](#)
[distances](#)
[graphs](#)
[links](#)
[profiles](#)
[map](#)
[services](#)
[users](#)

---

created: Tue, 11/01/2005 - 09:36 — rroca - updated: 04/12/2012 - 11:38pm

Nou Supernode que substitueix al del Femer. És al costat i en un punt molt més elevat, el que li ha de millorar la eficàcia sense haver de tocar les antenes que ara connecten amb el Femer.

En un principi està previst que disposi d'enllaç troncal amb les antigues Escoles de Gurb i el Supernode del Seminari, i que amb dues sectorials, una pel sector nord- oest i l'altre pel sector nord i nord est, per a connexions dels veïns de Gurb.



node	1706 GurbCEPA	<b>Gurb CEPA</b>
zone (mode)	Gurb (infrastructure)	Amistat
position (lat/lon)	Lat:41.940083 Lon:2.242527	15 meters above the ground
available for mesh & status	Yes	Working
graphs provided from	6836-Gurb, GraphEsperanca	

**contact information**

created by: rroca at 11/01/2005 - 9:36am - updated by: vicmartins at Sat, 20/11/2010 - 15:33



**COOK Report:** Do you have a list some where of the kinds of radios used in the backbone?

**Roca:** Over ten year's time there are many. We are not tied to any single vendor and consequently we use any kind of hardware that works well. The electronics all be-

comes obsolescent within two or three years and over the last 10 years we have been using radios from dozens of companies. What we call a supernode is a node with several radios and several antennas Which can be made by many companies.

#### devices

device	type	ip	status	last available	unsolclic
GurbCEPAST1	radio	10.138.12.65/27	Working		RouterOSv4.7+
GurbCEPAST2	radio	10.138.12.97/27	Working		RouterOSv4.7+
GurbCEPAST3	radio	10.138.16.129/27	Working		RouterOSv4.7+
GurbCEPAST4	radio	10.138.14.33/27	Working		RouterOSv5.x
GurbCEPAST5	radio	10.138.14.161/27	Working		RouterOSv4.7+
GurbCEPASwitch	generic	/	Working		
GurbCEPAPC	generic	/	Working		

You are not allowed to update this node.

#### links (wds)

linked nodes (device)	ip	status	kms.	az.
<b>GurbCEPAST1 - GurbCEPARocLlarg</b>				
7257-SBGRocLlarg (SBGRocLlargST1/SBGRocLlargCEPA)	172.25.0.222/172.25.0.221	Working	6.226	318-NW
<b>GurbCEPAST1 - GurbCEPAPavello</b>				
4962-GurbPavello (GurbPavelloAP/GurbPavelloCEPA)	172.25.1.125/172.25.1.126	Working Up (100.00%)	1.88	339-N
<b>GurbCEPAST2 - GurbCEPAPonent</b>				
66-GurbCamprodon (GurbCamprodon)	172.25.0.193/172.25.0.194	Working Down (0.00%)	2.01	290-W
102-GurbCMundo (GurbCMundo)	172.25.1.81/172.25.1.82	Working Up (99.85%)	1.022	326-NW

Talking in very general terms in the beginning the majority of the ordinary radios were made by Linksys the American company. Afterwards, the situation was very much dominated by Mikrotik radios and lately Mikrotik has been losing share in favor of Ubiquity. Originally the ubiquity radios were a "customer premises device" in other words for end-users but with AirFiber of course they have developed a very interesting backbone product that we are just beginning to test.

Now getting back to geography, the Gurb region where I live was where guifi.net started. There are other regions. For example one is [Barcelona](#). We only have about 65 nodes in Barcelona–this in a density of population of about 4 million.

**COOK Report:** Well there are many many other opportunities for getting connected to the Internet in Barcelona, I imagine.



**Roca:** True but we should be getting access to some fiber in the Barcelona area and experience better growth there.

**COOK Report:** In the diagram of Barcelona on this page I am thinking that must be line of sight connections from tall buildings for radios correct? Or is it fiber?

## Barcelona

availability data map networks nodes pending/review services suppliers  
users queue

created: Mon, 01/08/2005 - 22:10 — webmestre - updated: 30/11/2012 - 10:38am

Bloc de notes compartit on podem afegir canvis importants de la zona de Bcn:

<http://etherpad.gulfi.net/barcelona-estat-actual>

SAX!! 😊

### zone information

zone name	BCN - Barcelona
default proxy	11377-Barcelona, BCNSettProxy
default graph server	24760-Barcelona, BCNAragoOlostSrvGraf
network global information:	
Mode	Infrastructure
DNS Servers	10.138.27.194,10.139.6.130
NTP Servers	10.138.27.98,10.138.27.194
OSPF zone	
Time zone	(GMT+01:00) Gurb, France, Germany, Italy

### contact information

created by: webmestre at 01/08/2005 - 10:10pm - updated by: eloi.rebes at Fri, 30/11/2012 - 10:38

zone statistics

## Nodes listed at Barcelona

Zone name	Online	Planned	Building	Testing	Total
Núvol de Gràcia	17	39	2	6	64
Núvol de Sant Martí	22	19	1	0	44
Núvol Sants-LesCorts	18	29	0	1	48
Núvol UPC Campus Nord	5	15	0	0	20
Núvol Vallcarca	5	4	0	0	9
	67	106	3	7	185

**Roca:** It's not fiber we do not have the software yet that will allow us to map the fiber in our network. We have our fiber hard coded in our network operational software but we do not yet have the means of displaying it on the GoogleMaps.

there are other issues as well. We have found out that that the bigger the city the more essential is the collaboration of the local government. This is so for many reasons: because its is more difficult to get permissions to implement projects. Because the people are more isolated from each other, dissemination campaigns are more important). Barcelona local government not only has never supported guifi but has fought against it, very likely due to the issue of urban elitism and privilege.

**COOK Report:** Excellent points! You have absolutely remarkable interactive Network Maps on your website but I am wondering if you have anything that explains how you spread out to other parts of Spain or even to a few other parts of Europe or elsewhere the city of Bogotá in Colombia for example.

## The Three Pillars

**Roca:** When we try to expand to another part of Spain ***we have a process that we try to use and that we describe as a "quick win in a short time."*** ***If we take on a new project and don't provide positive results, the local people we're trying to work with will get discouraged.*** That is one of the key points. The other is that you have to involve in the very beginning what we call the three pillars.

One is citizens and second is public administration [local governments] because very often access to roof tops is needed. Now public administrations are also important especially in places where we don't have access to fiber because, when new people join the network they want to get connected to the global Internet as well as to each other.

So public administrations deal with libraries and schools that normally have Internet access across the entire territory of a given public administration. Now these entities are already public in the sense that their connectivity has been paid for by the taxpayers and so what we do is install proxies in these entities and then by the use of nearby radios share that access with the result of giving more people in the public Internet access at no cost.

Now the third pillar is composed of the professionals about whom we were talking in the beginning and who are motivated by a culture of do-it-yourself because they have more knowledge than the general public. As a result then we train them as professional employees. They are tied to that territory and we give them the tools and capability to be able to install radios for people who want to join the network in the new territory.

When all of those three things happen, we can take on a new project in a new territory and have good hope of getting good results within a few months. Those are the ingredients we need and when we have them we go public. When we have laid this kind of groundwork we schedule public meetings in theaters and in other local places appropriate for this kind of announcement of what we have done. We tell people that they can take what we have done and point out the steps by which they can either self install or pay someone who we have trained to install them on the new extension of the network. This is very much the process that we are following.

## The Supply Chain

When I am talking about everything that needs to happen, much needs to happen together. ***If there is a lack of cooperation by the public administration, then everything will go wrong. Everyone needs to be involved. This is not something that a single corporation or a single citizen operating on their own can accomplish.***

**COOK Report:** You point out that "TCO should be reduced" by working with capital expenditure and operational expenditure instead of fees. You use the term TCO - is that total cost of ownership?

**Roca:** Yes. Total cost of ownership. For example you can come to Telefonica which offers lots of fiber but you will find that Telefonica charges a business €1000 per month for use of that fiber to provide only 10 MBs per second of data service.

So what I mean is that, after a year the total cost of ownership for company to be online can be €12,000. However if you own your own infrastructure, after one year the total cost of that ownership will be far less than the €12,000. For this to happen, there must be cooperation. But with cooperation the total cost of ownership becomes much less.

**COOK Report:** When this slide on page 76 below says "missed demand due to the lack of diversity of business models", I think what you are telling me is that when you go to a new group of people, you will have an understanding of who these people are you will have in your arsenal many different models so to speak that you can explain and pull out of your hat to fit the needs of your audience and to present the kind of business model that will be applicable to the community to which you are introducing the network.

**Roca:** Yes. But the slide has also another purpose. In the beginning many people were saying yes you're succeeding because you are going into unserved areas. Originally this was true but over time, even in areas with some service, we are doing better and better.

Let me give you an example. One instance of companies who are applying more pressure to us are large enterprises -- not telephone companies but manufacturing companies, trading companies, research organizations, and institutions of education. Now many of

these organizations are saying to us: take a countrywide location and provide us fiber and to be honest I am not sure that I will use your fiber as opposed to fiber that I could get from Telefonica because having a choice of someone else is the only way that I will be able to negotiate with them. This is one of the points. The other point is ***public administrations, which are one of their biggest customers, are a source of money for the telecom operators. They were spending millions of euros for the ostensible purpose of fighting the digital divide because these millions of euros were going straight to the Telcos.***

Ironically now we are starting to get some cooperation from the European Union but not from the Spanish authorities, at least not at the same level. We are successful at cooperating with local administrations, local villages and others but we are not successful in cooperating with other higher level government government administrations. They would much rather keep Telefonica happy. But when we go to Brussels people are very happy to hear about regions like ours that are successful in introducing local competition.

Telefonica is the biggest company in all of Spain. When privatization came to the telcos in Europe unfortunately they kept them in one piece rather than breaking them up. Also the board and staff of Telefonica has many important former politicians which further makes things difficult for us.

## **C4EU Kick off**

**COOK Report:** Can you tell me a bit about the C4EU Kickoff. It sounds like this is what you are saying when you mention Brussels. Tell me what C4EU is all about. Have you gotten some monetary support from Brussels?

**Roca:** Yes. While we got no help from the Spanish or Catalan government, in 2010 Nellie Kroes on behalf of the Digital Agenda 2020 in the European Union talked about access to fiber for everyone said that "I know it will happen but not the way things are now, so help me make it happen by giving me ideas."

We were happy to answer her request with our idea of "Bottom up Broadband." But there was no money involved. It was only about providing ideas. However after that by becoming a Living Lab what we are doing in Spain became perceived in a very positive manner. In Brussels they do some framework programs and provide funding for universities and other entities looking for positive solutions. By following those ideas we were in a very good position to ask for funding for one of the projects. Commons for Europe -- [C4EU actually has a website.](#)

These projects are not given to a single entity but rather to a consortium. Now the Commons for EU consists of several packages and we are the leaders for Working Group Number 7 which is called Bottom-up-Broadband. This project is framed around the idea

of a commons. Do you know the [Code for America](#) experience? [Code for EU](#) is very much the same idea of [creating software as a commons](#) and then sharing it and developing it further among the partners. We are now doing the same with regard to telecom infrastructures with Bottom Up Broadband (BuB4EU).

It is designed to allow the citizens to hack -- in a good way -- public infrastructure. Now what does this mean? Suppose there is a railway or road that has fiber running along it the idea is to attach fiber to that already existing infrastructure and use the result as a public commons since it is already being paid for by the tax payers. For a public administration there are two choices. Here one is to give such infrastructure to private companies who will operate in a private way as is being done with the telcos **or manage it as a public infrastructure so that everyone is able to use it. Use it and improve it by expanding it, is why this concept here makes sense. If there is something wrong with the infrastructure and we are allowed to use it, perhaps then we will be more than happy to fix it.**

[Commons XOLN](#) is defined on our website. **It means that if you create a node and add it to our network, you will need to accept the terms and conditions of Commons XOLN.** It is an acceptance that certain rules will apply such as open Peering. Having a clear license which must be accepted for joining the network (in a viral license fashion) has proven to be one of the key factors to explain [guifi.net](#) scalability. A clear set of rules accepted by everybody, i. e. a clear common framework, fosters investments, participation, etc. and reduces community misunderstandings and conflict. [Xarxa Oberta, Lliure i Neutral \(XOLN - Neutral, Libre and Open Network\)](#) is the [guifi.net](#) license. a reference to the English version would be great, but at the moment I do not know where to find the latest English version). Essentially it sets the traits of the network (namely neutral, libre and open - i. e. In Commons) and guarantees that they will remain unaltered in the future regardless of future build outs

Two concepts are problems are being solved by XOLN. Transit like Internet is free. To make an infrastructure company, you assume that that infrastructure has an owner who paid for it. So that owner has two choices. One, if he keeps the ownership, he is able to provide quality of service and will have priority of transit when others want to get connected with that particular segment. If that link costs €1000 and we are getting 6 people connected by means of it, then we will divide the cost by six and you will not be any longer the single owner of the fiber link. The cost of the infrastructure must be paid for and the only thing that is free is that we are not charging for transit within the network. That is why you might have to get connected to some other network segment and why you might have to pay something that leads to alignment with the real cost. Now for the provision of transit to the rest of the Internet that goes through real carriers there will also be a charge.

At some point you will have to get connected to another segment of the public internet and in this case what you pay will be more aligned to the real cost. The provision of transit to the rest of the Internet that goes through carriers just like a service. Users can



have and share those services or professional services can provide that to the users. We don't have a price list. We are always based on cost. End cost for the users who contract for those services are very much connected with the prices that professionals are charging the users. I was including that in the €20-€30 that a gigabyte fiber charges every user at the end of the month.

**COOK Report:** How is the current terrible economy impacting guifi.net?

**Roca:** Favorably, we are still growing very rapidly. People need connectivity. And the problem is not in the business model because our business model now makes more sense than ever. Ten years ago it seemed that working technology was very speculative. Everybody wanted to do the next very rich IPO. But now the situation has changed greatly and the emphasis is on sustainability. The fact that we are still represent a very tiny percentage of the entire market this means we have a large space for growth. But as we get bigger, we attract more opposition that sometimes goes way beyond any kind of ethics. We have seen nasty things from big ones trying to block us

In interactions with our technical people and suppliers they could be very sophisticated and these people would say "Ramon we are afraid of working with you because Telefonica told us you do not have the proper permission to be working on these poles." In a sane economy traditional telcos should be able to convince their customers that they can offer good service at a reasonable price because this is just the way they do business rather than because they are the biggest kid on the block that throws its weight around. One of the golden rules is that capitalism works only if there is competition.

**COOK Report:** A couple of clarifying questions. When you talk about 19,000 nodes, a node is a place where there is a physical connection to the network and each node could be a house or a small business or a school?

**Roca:** Yes We know exactly how many nodes we have but we do not know the precise number of people depending on those. We can deduce statistically that there are about 3 people per node.

**COOK Report:** And the cost of the network is really the cost of each node?

**Roca:** Yes.

## Further Explanation of guifi.net Terminology, Commons, Fiber and Business Model

**Editor's Note:** Ramon joined the Arch Econ list a few days after our December 6 interview and over the next few days we clarified many important points. Ramon asked on December 10.

**Roca:** I'm seeing here some people who seem to be involved in fibre projects for communities. For those projects we do think that one of the challenges (among many) is complexity (experiences, logistics, technical, operation, socio-economics, network management & provisioning, inventory...). One of the ways to address that is to create a collaborative place to assist those communities, share resources and knowledge, in a similar way we did for [guifi.net](http://guifi.net) for wireless communities, but on a world wide scale.

That might start with something like a website. I'm wondering if you share this point of view and if any of you would like to get involved on this. **[Editor:** Over the next few hours, Ramon received responses from Holland, Canada, Maryland, Louisiana, Minnesota, Virginia and Nebraska.) Late on the tenth he added:

Thanks for all comments. I appreciate them. Let me try to share with you where I want to go a bit further and be a bit more precise.

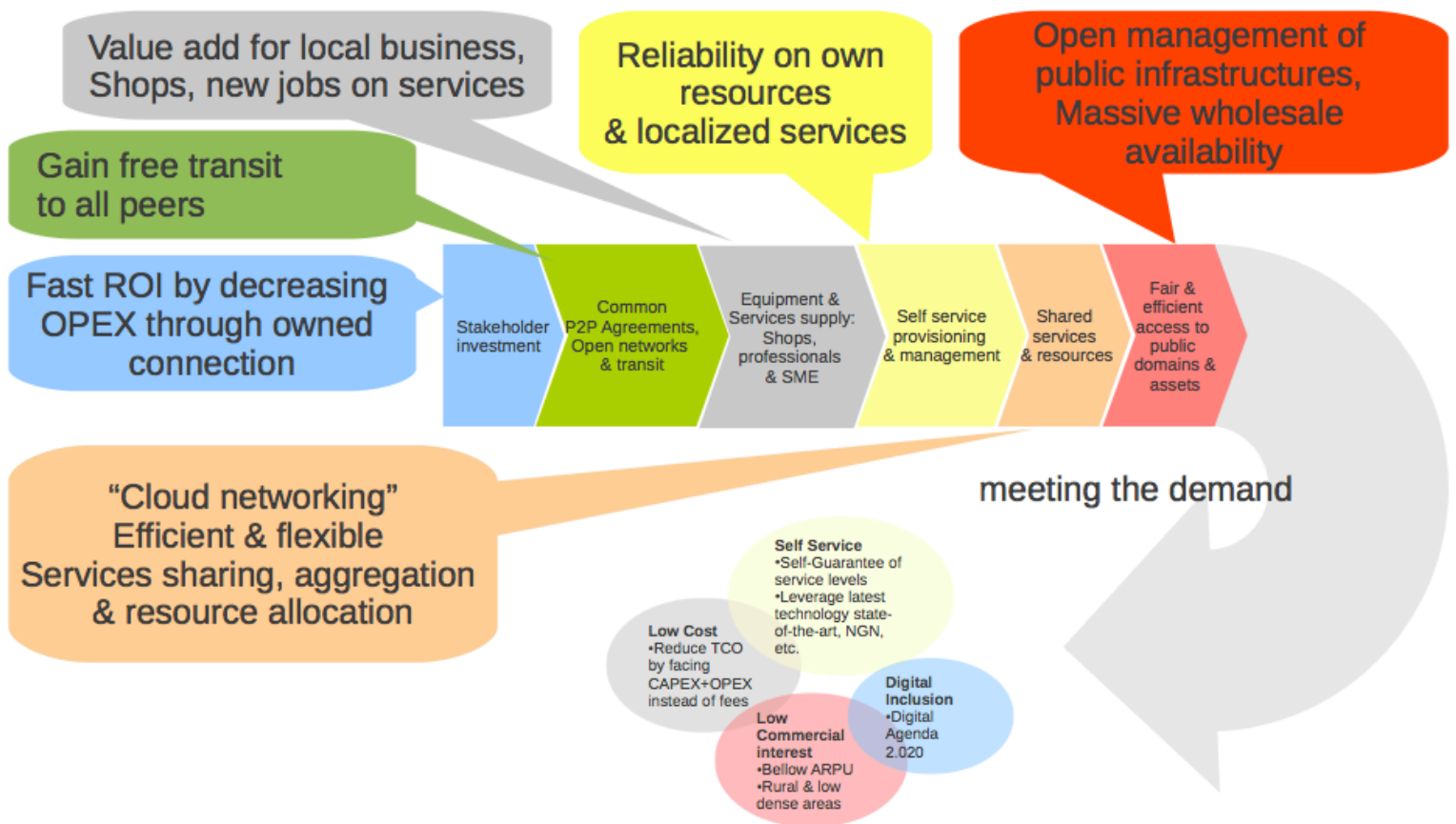

You'll realize that we have provided many examples of distinct types of networks based on the ownership (municipal, wisp/isp, community...). Ownership varies, but business model is still very much the same in all of them: Is centered on the infrastructure owner, you are

## Missed demand due the lack of diversity on business models

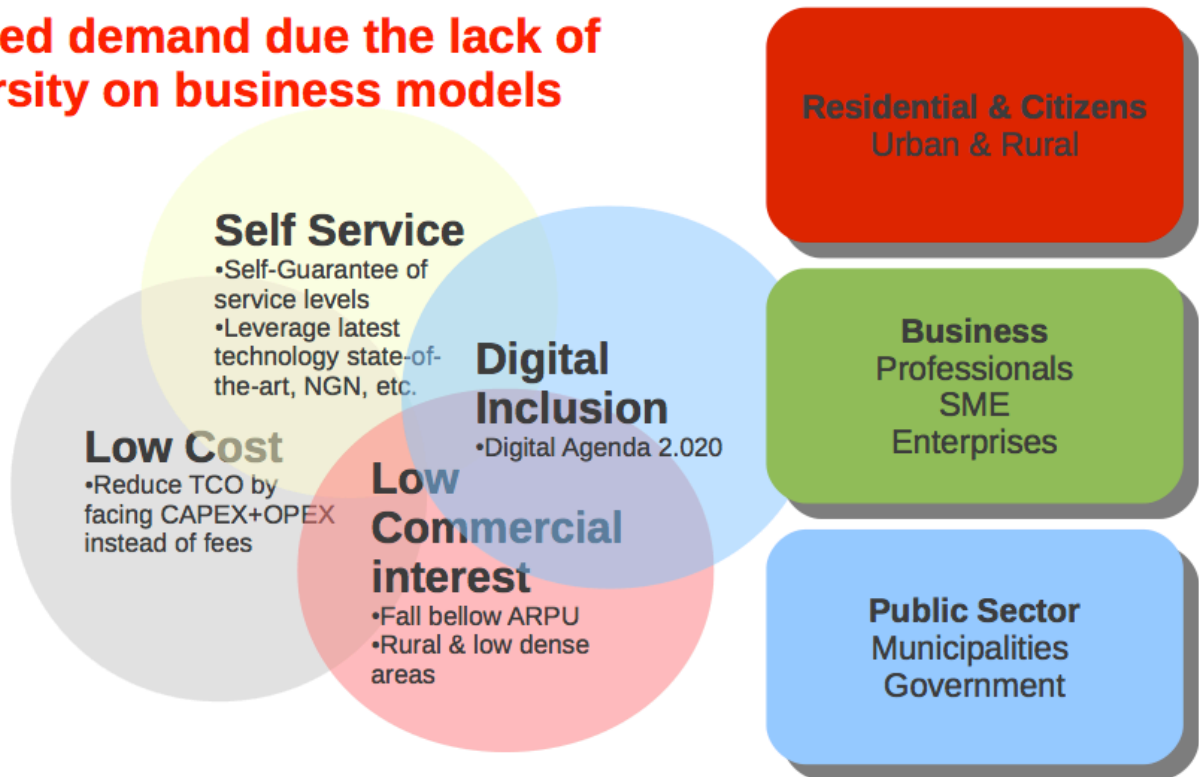

either a member or a customer, and rules apply depending on which one you are related, regardless of whether the network is for profit or not.

When I'm referring to BuB or Commons, I'm not looking into the type of ownership. There can be many types. In fact hopefully there will be all of them at the same time. We focus on when the economic model instead of being derived from the ownership, comes from alternatives like providing materials or services to it. For example with regard to the network -- professionals, SMEs, etc can charge for their services for ensuring SLA, fixing problems, sell equipment, installations and deployments, etc.

In addition there is an agreement for aggregation of infrastructures provided by many that is operated as a whole and such whole becomes a commons regardless of who is the owner of every single network segment.

**COOK Report:** By commons do you mean a set of uniform rules under which everyone agrees to operate?

**Roca:** Strictly by Commons I mean something that regardless of the ownership (private or public) and how is financed, is it **formally given as an asset available to all under the same conditions**, like a park, a road or a street?



In telecommunications that means requirements for a basic standards to ensure interoperability and capacity to grow by interconnections etc like IP addressing rules, routing, etc..., and essential, make everything publicly available to allow everyone to enhance. Not everything can be discretionary to the network's admins, if the network is managed discretionary, would become in fact an intranet or a private network (I've seen many cases where owners do say they run a commons network, but in fact, looks to me a private network, since the only way to get connected to it is becoming part of a specific organization).

We do have self-service apps for assistance in provisioning the network, addresses, routers configurations, etc... That's a major challenge. No membership required, any user/org can connect and manage at their own.

Internet is a network of networks with no single owner but a result of the interconnection of networks from ISP, and thereafter those ISP do provide their connectivity to it to their customers/members (top-down approach). Now try to imagine the same concept of network of networks, but built from the bottom, and from the edges (bottom-up).

**COOK Report:** Well yes but how? Examples please. In traditional commercial networks much is done under non disclosure in the bottom down. In bottom up i think this is not possible. Am I correct?

**Roca:** No, interconnection can happen both, bottom-up and top-down. Just changes the way it is deployed, the logic behind things.

Another analogy, I'm sorry if you find them too much simplistic, but for illustration purposes, could be a network of no-toll based roads, several builders, owners and financing methods apply, but at the end, but none of them are based on direct transit fees to the users of the infrastructure. Also the open source, where might be no license fee, but services around it...

**COOK Report:** So complete transparency? Complete openness?

**Roca:** Yes. In this scenario, it makes a lot of sense to scale and to aggregate (is when value comes). The sharing of resources and methodologies, becomes key.

**COOK Report:** Well yes.... but give examples please of who is sharing with whom and for what? How is ownership invested in the guifi foundation? This is a very critical question.

**Roca:** What is in Commons is what is determined by the p2p agreement (Comuns XOLN). Essentially it is the network itself. Anything else is outside of the Commons agreement. However, to be in a Commons and next to an already existing deployment doesn't necessarily mean that has to be donated to the [Guifi.net](http://Guifi.net) Foundation.

Now I'll describe for you a real world example for financing fibre deployment in rural areas that we have recently applied, which is very much a complex process, but one that is proven to work.

## **GURB Nord Project Phase 1 2009- Business Terms**

### **1.-CAPEX (passive)**

1. We go to a rural neighborhood that is next to another which already works.
2. We say to them that, if they want the the fibre to be extended to them, we do need to supply financing.
3. Total cost will be shared by all of them equally, so final cost will depend on how many of them will be interested on having it.
4. Since there is a need for money in advance (materials, etc...) we do need some financing in advance. In this case we don't take risks of going to Banks or Financial Institutions for that.
5. To encourage investment, those who are interested, and give money in advance, will have a discount of 20% at the time the final cost is calculated. Project will not start until there is enough financing for materials.
6. To avoid speculative positions (people that don't connect at the time the infrastructure is deployed, but wait to the next years with the hope that since the infrastructure is already there and paid, so hopefully we will get connected without having to afford the cost) we state clearly that once a cost will be fixed as described in step 3, the connections the years after will be at that price plus a penalty, and these funds will go for maintenance.

### **2-Illumination (active)**

Once we have the passive infrastructure on place, everyone has to pay the cost of it's activation (some might want to wait, cost also could be very much distinct according to every house characteristics, etc...)

### **3.-Operation**

We do calculate the cost of maintaining this infrastructure and amortizations, then we charge that to the service providers who want to provide services to the users through that network (everyone can) there (in case of something goes wrong, VoiP, etc...). Note that everyone can provide services on this infrastructure, users are free to contract services that they want. They charge that to their services and provide financing for it.

That was just an example. Another example coming next year is a industrial company that needs fibre, and already having some expensive fiber. They finance the deployment of another fibre, so then will be able to negotiate cost with their current provider. Close to that Industry are some urban areas, so the service providers can recover part of the investment by

allowing connections to it and share cost in a similar way as the previous example. In this case, there is no need for advance money from anyone else.

Often I do see people referring to us ([guifi.net](http://guifi.net)) as one of the largest wireless communities, but this might not be accurate in all ways: The trick is that we aren't a truly single community, we do aggregate many communities, municipal and private infrastructures through a p2p agreement which establishes the Commons (and everyone can subscribe regardless of the ownership). But still very much a local (or regional) experience.

**COOK Report:** Is this what you would consider open peering? Every region exchanges traffic with every other region without charge? What happens when traffic gets out of balance and the biggest region wants to charge smaller ones?

**Roca:** They can't. If a region manages their network improperly, what will happen is that this network will not work. Not for them and not for others who rely on them for transit and will find other options, Interchange costs to the rest of internet are shared and passed proportionally by following "showback" or "chargeback" rules model to whomever uses them. Those rules have to be public.

**COOK Report:** Thank you Ramon. Let me try to answer. A guess on my part is that you want to establish a knowledge inventory of where and how to find out where interconnect points are located, where to find costs for interconnection, purchase of IRUs, regulatory case law.... that sort of thing?

**Roca:** The way that I would put it is that there is a need to have an agreement for aggregation of infrastructures provided by many that is operated as a whole and where such whole becomes a commons regardless of who owns every single network segment.

**COOK Report:** By commons do you mean a set of uniform rules under which everyone agrees to operate? But how will you achieve this?

**Roca:** Internet is a network of networks with no single owner but is the result of the interconnection of networks from ISP, and thereafter those ISP do provide their connectivity to it to their customers/members (top-down approach). Now try to imagine the same concept of network of networks, but built from the bottom, and from the edges (bottom-up).

**COOK Report:** Well yes but how? Examples please. Much is done under non disclosure in the top down way of working. In bottom up i think this is not possible. Am I correct?

**Roca:** Yes. On our bottom up approach non disclosure doesn't happen. Let me try another example -- could be a network of no-toll based roads, where several builders, owners and financing methods apply, but at the end, but none of them are based on direct transit fees to the users of the infrastructure. Also for the open source, there might be no license fee, but a cost for services around it.



In this scenario, it makes a lot of sense to scale and aggregate (which is when value comes), sharing resources and methodologies, becomes key.

**COOK Report:** Well yes.... but give examples please of who is sharing with whom and for what? How is ownership invested in the guifi Foundation? This seems to be the critical question?

**Roca:** Often I do see people who refer to us ([guifi.net](http://guifi.net)) as one of the largest wireless communities, but this might not be accurate in all the senses: The trick is that we aren't a truly *single* community, we do aggregate many communities, municipal and private infrastructures through a p2p agreement which establishes the Commons (and everyone can subscribe regardless of the ownership). But in every case it is still very much a local (or regional) experience. So now I'm trying to imagine a step further, more global, and including fibre.

**COOK Report:** Great... I applaud. But once you exceed a certain size you have so called publicly owned companies who must return benefits to shareholder who often and in fact most of the time are not the users of customers of the network. So the critical question needs to be whether you can do this with the money needed - the capital being provided only by the builders and users and none coming from third parties.

**Roca:** No, there is no need to establish a single organization to manage that. There can be many such organizations operating with just a single non-profit Foundation ensuring the Commons. I hope my previous examples did illustrate this.

**COOK Report:** If you have to get money from a third party, then it seems the commons becomes difficult or more likely impossible because the source of money will want to give the part of the network it is closest to or it likes best and advantage over the other parts. It wants a winner. But to have a winner other parts must loose? Can you have non disclosure agreements and a commons at the same time? I don't think so. But I will say this -- you have a remarkable collection of brain power [HERE](#) - on this list - and that collection perhaps can answer your questions in ways that I operating alone cannot.

**Roca:** We can't have any NDA within the networks based on Commons. Strictly forbidden, every bit of information, term, etc should be made public. Third parties, i.e. providing interconnect to other non-Commons networks, that is to say. the rest of the Internet, might ask for. It is the case the case of some in Spain. In my opinion NDAs are a very dirty business practice since often there are public infrastructures involved..

Then at 2:22 am December 11 **Roca:** [I agree with the interpretation as you just outlined it.](#) What you see on the map, the whole network, is like a neutral interchange distributed across the territory. That's a consequence of our being between 2004 and 2009 formally established as a Commons and a neutral network. But as you look at those maps, you will miss some

service	zone	device	status	disponibilitat
<b>Internet access trough a proxy</b>				
Proxy, Vilafranca del Penedès, StPere	Vilafranca del Penedès	CarrerStPereServer1	Working	Up (100.00%)
Porta a Internet de DigiCape2	Capellades	CapelladesLaLigaServer1	Working	
Porta a Internet de DigiCape1	Capellades	CapelladesPonetSrvr1	Working	
Proxy de Buff - Igualada	Igualada	IgualadaRedRecServer1	Working	
Porta a Internet de Cal Font	Igualada		Working	
Porta a internet d'espelt.net	Igualada	espeltnet	Working	
Proxy d'IGLU - Igualada GNU/Linux Users	Igualada		Working	
Proxy a Internet d'ontanem.net	Igualada	ontanemnet	Working	
PdATel-SatSrvr2	Platja d'Aro		Testing	
Porta a internet de Platja d'Aro (Federat IN/OUT)	Platja d'Aro	PdACentreSRV	Working	Up (100.00%)
Porta a internet de Tel-Sat (Federat IN/OUT)	Platja d'Aro	PdATelSatSrvr1	Working	Up (100.00%)
Castelldefels-Proxy (Federat IN/OUT)	Castelldefels	CastelldefelsWireless	Working	Up (95.46%)
Castelldefels-Proxy2	Castelldefels	CstlIdfIsWifiCAT	Working	Up (100.00%)
Servidor Proxy de Correu BCNOnzeSetembre11	Barcelona	BCNOnzeSetembreServer	Working	Up (100.00%)
Servidor Proxy de Barcelona - BCNguipuscoa	Barcelona	BCNguipuscoa87Europa	Testing	Up (99.89%)
Servidor Proxy de Barcelona - BCNHangar	Barcelona	BCNHangarFusion	Working	Up (100.00%)
Servidor proxy federat de Barcelona - BCNmargarit0	Barcelona	margarito	Working	Up (99.81%)
Servidor Proxy de Barcelona - BCNmasGuineueta (Federat IN/OUT)	Barcelona	BCNmasGuineuetaSrvr1	Working	Down (0.00%)
Servidor Proxy de Barcelona - BCNMistralRocafort	Barcelona	BCNMistralRocafortSrvr1	Planned	Down (n/a)
Servidor Proxy de Barcelona 50Mb-BCNOnzeSetembre11 (Federat IN/OUT)	Barcelona	BCNOnzeSetembreServer	Working	Up (100.00%)
Proxy Federat BCNRossello208	Barcelona	BCNRossello208Fermat	Working	Up (100.00%)
Proxy socks BCNRossello208	Barcelona	BCNRossello208Fermat	Planned	Up (100.00%)
Proxy de Barcelona - BCNSett (Federat IN/OUT)	Barcelona	BCNSettServer1	Working	Up (99.77%)
Proxy Vallcarca (Federat IN/OUT)	Barcelona	BCNpsgMareDeuColl70Srvr1	Working	Up (99.83%)
Proxy a Les Planes [Collserola]	Barcelona		Testing	
proxy.elcarmel.guifi.net	Barcelona	BCNMurtra89Gintonic	Testing	Up (98.47%)
Servidor de proxy de 9 Barris	Barcelona	MITXet	Testing	Up (100.00%)
Proxy Federat a BCNsjmalta	Barcelona	BCNstJoanMalta51Srvr2	Working	Up (100.00%)
Proxy BCN AragóOlost (Federat IN/OUT)	Barcelona	BCNAragoOlostSrvr1	Working	Up (100.00%)
Proxy federat a BCNIorda17	Barcelona	BCNIorda17Servidoret	Working	Up (100.00%)
Proxy Xarx@ntoni a "Woodland" (BCN Calabria-Manso)	Barcelona	BCNXAICalabriaMansoSquid	Working	Down (0.00%)
proxy server knoppix	Olot	knoppixguifinet	Working	Up (100.00%)
proxy server knoppix backup	Olot	knoppixguifinet	Building	Up (100.00%)
Proxy socks Montolivet	Olot	MontolivetSrvr1	Working	Up (99.45%)
NAS Olot Geranis87	Olot	OlotGeranis87Srvr1	Building	Down (n/a)
Proxy Picasola Olot	Olot	OlotPicasolaSrvrNas	Working	Up (96.39%)
OlotBellaire8 Servidor Proxy	Olot	OlotBellaire8Srvr1	Building	Down (n/a)
OlotHackerspace Servidor Squid	Olot	OlotOlotHackerspace	Building	Down (n/a)
OlotMontolivet	Olot	MontolivetSrvr1	Working	Up (99.45%)
Proxy Carles Olot	Olot	OlotMontolivetCarleSrvr1	Building	Down (n/a)
proxyfreenasknoppix	Olot	knoppixguifinet	Testing	Up (100.00%)
Servidor proxy Olotvalezquez8Srvr1	Olot	Olotvalezquez8Srvr1	Building	Down (n/a)
Servidor de proxy Karma	Olot	OlotKarmaServer	Working	Down (n/a)
Porta a Internet de Calldetenes (Federat IN/OUT)	Calldetenes	CallAjServer1	Working	
Porta a Internet de Centelles - El Pipa (Punt Jove) FEDERAT IN-OUT	Centelles	EIPipaVM	Working	Up (100.00%)

things that are there in reality. Some of these things are because of lack of functionality in our apps, and also because of some NDAs that we had to sign with some wholesale suppliers. These NDAs prevent us from publishing certain information, which is a very inconvenient common business practice here.

You may finalize this information, in terms of an inventory of our "proxies", which are gateways to the internet by using regular commercial residential lines (e.g. ADSLs) you'll find [it by browsing our database](#):

**Find "Internet access trough a proxy"** section in that page. Press cancel if you get a dialog asking for authentication) Those are the gateways user from the very beginning. [Editor - the full internet proxy gateway list of which only the first small part is shown to the left seems to be a couple hundred entries long.]

From 2009 on we do

get also truly internet access by peering at a major Internet exchange. We do that by being [members at the Catalan Interchange point](#) (Catnix) that happens to be in Barcelona. Thanks to fiber, we do also have what we call "PoP-IX" (Interchange Points of Presence extended across the territory). Those are the ones that are affected by NDA forced by regional fibre providers. These have been setup mostly within the last year and are one of the most active parts in our development. Currently we can say that we have five, distributed across Catalonia and located at: **Gurb, Masquefa, Igualada, Tortosa, Manresa.**

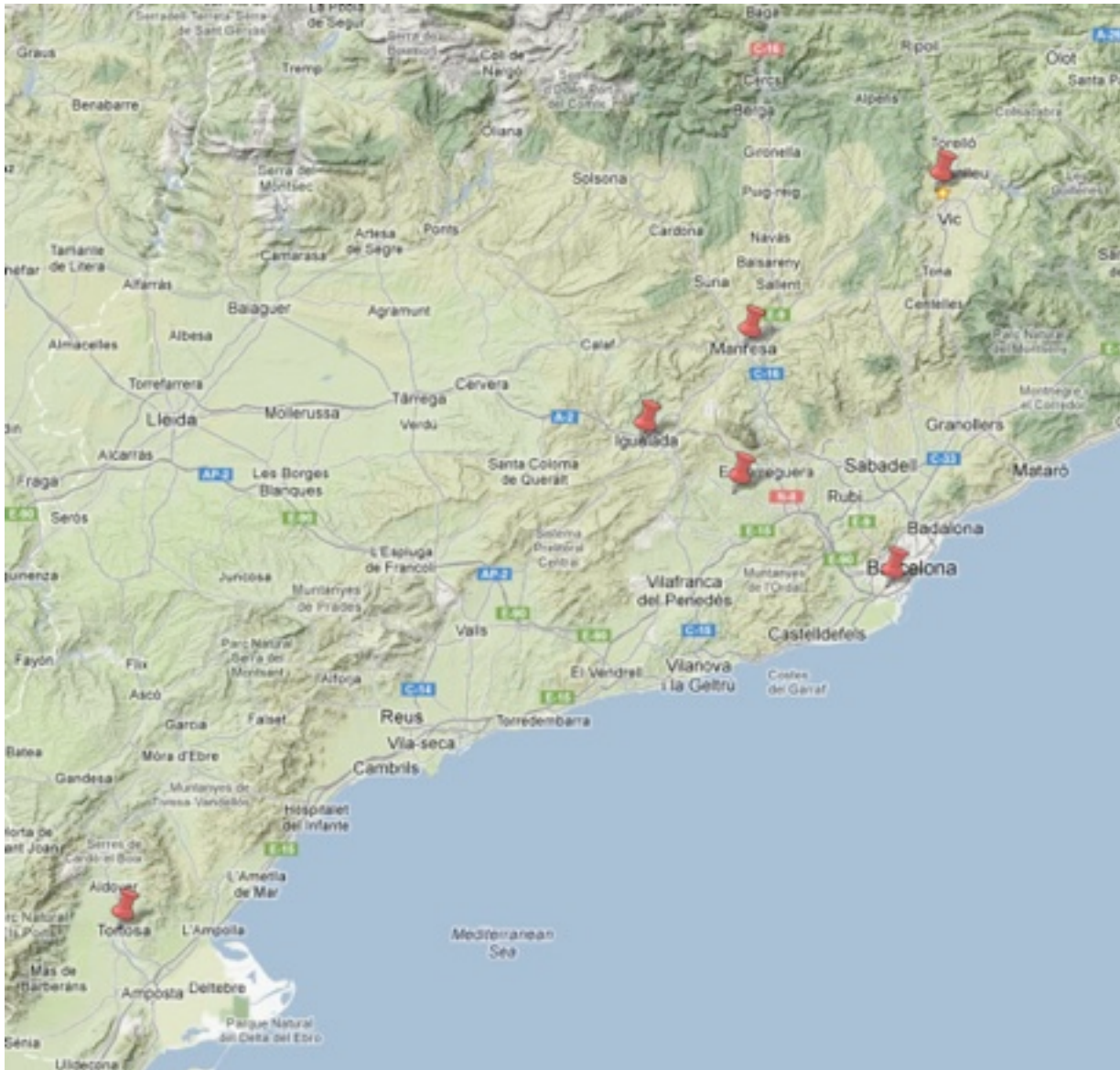

We had another in Girona but right now we are forced to dismantle it. Hopefully you'll be able to find those locations at google maps. Our goal is to provide FFTx access to those PoP-IX.

**COOK Report:** You also write "Our goal is to provide FFTx access to those PoP-IX."



When I do the other look ups you have advised in this message, will I understand where the FTTx access is? The POPix es are the five you have listed but where are FTTX? are they your supernodes? FTTx must be your supernodes. How many of those do you have?

**Roca:** Sometimes I think we have developed our own terminology to refer what we have, and have done this in a way that might lead to misunderstandings. Some definitions:

**Supernode:** Specific location which is doesn't have a single link (like a simple connection of a single home) but multiple, combining several PtP links and PtMP. Usually part of the network backbone where traffic gets aggregated/dispersed through several locations, serving coverage, etc. Also on wireless nodes, those who have multiple radios and antennas. There are thousands of them, mainly wireless. Eight now, just a few of them have fibre.

**Catnix** - Catalan Interchange point with local operators in Catalonia. Located in Barcelona.

The screenshot shows the CATNIX website homepage. At the top, there's a navigation bar with language options (Català, Castellano, English) and links for Contact and Private area. The main header features the CATNIX logo and the text "The Neutral Internet Exchange in Catalonia". Below this is a yellow navigation menu with links: Home, Who we are, Members, What we offer, Rates, News, Statistics, and Where we are. The main content area is titled "Catalunya Neutral Internet eXchange - Welcome" and includes a welcome message, a "HIGHLIGHTS" section with a featured article about Felix Baumgartner's skydive, and a "LINKS OF INTEREST" section with a thumbnail for IECISA. A "LATEST NEWS" section is partially visible at the bottom right.

**PoP-IX:** Nodes with fibre. They are also supernodes and have antennas since they also connect with the rest of our wireless network. Those locations (the ones which I listed before) provide a fibre gateway to the Internet and are in fact remote ports of the main node in Barcelona, where there is also the Catnix.



**FFTx** (Note the 2nd F instead of a T, we say "fibre **FROM** the homes/farms" as an opposite concept of the top-down approach, FTTx, where the operator deploys the fibre to the homes. Refers to the last-mile. We have since 2,009 connected some farms and super-nodes, but for some time we still have to go the rest of the internet through commercial subscriber lines, because of a lack of reasonable priced fibre connectivity at regional level. We started on 2009 with about 4 kms. Not mapped on our website apps, but mainly in Gurb. [**Editor:** This is the fiber described on pages 46-48 in the section above called "Gurb North Fiber Project." For the business case involved see above pages 78-79.]

Starting in 2011 at Gurb, and the others in 2012, those FFTx are starting to reach the PoP-IX's and thanks to this, get the full gigabit to the Internet. To provide figures, we have around 20 kms deployed in 2012 after work done this summer and following what we previously deployed in 2009. There might be in the range of some dozens of houses connected, all farms in dispersed rural areas.

With the deployments we recently made, we expect to reach urban areas by next year, and by that, we do expect growth, in the same way as happened on 2003/4 with wireless (starts slow, but increases exponentially), so be hundreds next year, thousands after that.

Regional fibre connectivity. That is public dark fibre that was already in place for years (at the roads, etc...), but not used. Not deployed by us. Was the most difficult part (deal with the public administration to find out ways for using that). You can imagine that there was important opposition for using those infrastructures in a more efficient way and injecting competition because of that. This is what links the distributed PoP-IX nodes to Barcelona.

Currently it is managed by a private company that won a public tender from the local administration. They force NDA in our contracts with them with what IMHO looks like a clear example of lack of transparency (They manage public assets!). Currently we might use around 300 kms of that fibre.

Finally guifi.net intends to create a bottom up broadband supply chain enabling self service where the goal is to meet this demand with an alternative based self-service proposition, so users can choose between outsourced provisioning or self-service models. To remark that by creating this supply chain is inherent that doing so increases supply alternatives and with this, competition. Furthermore develops an ecosystem around it and generates economic activity and employment.

**COOK Report:** What happened to Local Ret that started with such high hopes in 2005?

## **LocalRet - Good Intentions Go Astray**

**Roca:** After 2005, the Catalan Government decided it did not want to manage a province-wide telecommunications enterprise and held a public tender for a private company to

manage the taxpayer paid for assets. XarxaOberta is the name of a project promoted by the Catalan government aimed at connecting through optical fiber all the buildings of the Catalan government (i.e. town halls, hospitals, schools, etc.) to self-provide network connectivity. The project is financed via a 20 years long tender and the winner have the right to resell connectivity to third parties on a wholesale basis.

**XarxaOberta** is now the name taken by the private company that won the the public tender - a grant (€60MM) for managing the dark fibre already laid by the government and local administrations. Since the investment was still public, that's why the prices are fixed by the Spanish NRA (CMT). The 60M€ grant was just the initial amount of money. In 2012 the [final tender for covering all municipalities was assigned to Imagina-Axia](#) for 20years for a total amount of 253M€ You can take a look at [the prices here](#): You'll see there that they begin their "service" by charging 417,49€ for just 100 Megabytes per second on a monthly basis!

XarxaOberta only began operations in early 2012. Jordi López Benassat was the Localret CEO from March 2006 to April 2009) By the time that XarxaOberta began operations Jordi López Benassat had already left. During 2011 we were able to do the same job, but just "by exception," between Gurb and Barcelona, only after strong protests (we already laid fibre in Gurb on 2009 and still waiting for more than a year to connect). During the time in 2011 that we operated that dark fibre, we were doing it at a fraction of that cost. In fact, since the fibre was already there, the cost of operation was nearly zero.

But now we have been forced to switch to XarxaOberta which is a joint venture with [Axia](#) (I believe they are Canadian), and Imagina-Mediapro. [Mediapro](#) was in bankruptcy at the time they won the public tender. The current managing director of XarxaOberta is the former public official who at that time, was in charge of the public tender.. So why go backwards? It's said that "Caesar wife's must be above suspicion", but I feel that's never the case here when private companies gain exclusive control of public infrastructures.

Let me illustrate with some local examples: Telefonica is known for hiring former influential or well connected politicians. When it was privatized, it was given to a friend of the prime minister at that time. The CEO [Mr. Villalonga](#) resigned just after some scandals with stock options and left Spain. He is now happily living in Miami. The current CEO, [Mr. Alerta](#), was found guilty for using privileged information while trading with his company's stock, but too late and so benefited from from what he did. They hired the Spanish King's son-in-law, Mr. Urdangarin, until he got involved in a corruption scandal which is still now in court. They also hired the wife of Mr. Rajoy (current prime minister) and the husband of the vice-president, Ms. [Saenz de Santamaría](#). The last appointment at Telefonica Board happened just a few weeks ago. They hired former IMF President Mr. Rato, who later was in charge of Bankia at the time that become the largest Spanish financial institution to fail. Knowing how difficult is the current financial crisis in Spain, I don't think that this is the best marketing for Telefonica.

The last major telco public tenders in Catalonia were given to a single participant of that tender, one was the mentioned for Xarxa Oberta, other for Telefonica. A long time ago there was another for wireless rural broadband given to a company called Iberbanda, and just after the tender, Iberbanda was bought by Telefonica. Finally, the official who was in charge of the public tender when completed joined the board of the new company.

The question then is how many parasitic business models based on subsidies do we have? In an environment like this, you'll never know. Whatever the case very likely, too many. I'm not saying that everybody is corrupt. I still believe in the principle of innocence. But this is too much, because it looks like these practices become business as usual and go on and on. That's the big problem I told you about. Too many people just tell the public administrations that since they may not have the expertise to operate this network technology, they have to give their assets to private sector in a public tender. I would challenge that concept however. Because as long as they gain control the public tender process, and get a contract designed to benefit them, they, will be reluctant to accept any other alternative, such as our concept of managing the public infrastructure as a Commons.

As a conclusion, everything lead by public administrations [local governments] should be done transparently and diversely, but unfortunately, and if you look at the results, this hasn't been the case.

## Our experience: Cost sheet, 1 Gbit circuit €/km



1Gb circuit	Kms.	Activation	€/Month (*)	Now		Goal	
				mo. fee	%	% Share	mo. fee
Wholesale(**)	40.000	5.000	1.034,72	0,03	0	0,01	0,08
Barcelona - Vic	70	2.000	41.710,75	595,87	96,13	9,99	2,66
Gurb/Vic - FFTF	1,60	3.000	23,96	23,96	3,87	90	23,96

• **What happens?**

- Internet wholesale & Gurb/Vic – FFTF(\*\*\*) are multipurpose and interoperable IP networks
- Barcelona-Vic is closed and private (dark fiber/adif), so becomes 96,12% of the cost

• **Conclusions**

- Need for creating open, multipurpose and interoperable networks across territories
- Cost for regional wholesale network is around €2,67/mo., not more
- €30/year per final F.O. connection would be a reasonable levy for access to those infrastructures

(\*) Amortization 12 years  
 (\*\*) Traffic, aggregated  
 (\*\*\*) FFTF = Fiber From The Farm

That's also why I'm saying that [XarxaOberta](#) is now in fact very much like another incumbent. It takes the investments in fibre from public administrations, and manages it for wholesale but instead of at a real cost prices (like we do), at a prices fixed by a National Regulatory Authority looking at a market basis where there is no competition! Absurd. It ends as a parasitic business model based on subsidies. Since XarxaOberta in effect privatized the Localret fiber we rode to Barcelona, in 2012 we wound up with this situation. One which is probably still very far from Jordi's original concept as told to you in his interview with you. [If you check this result with the interview you wrote about that more than seven years ago](#), you'll realize that the result came very late, and was still far from the original scope. Localret (you're right, ends with a "t", but is in a single word, although if you say it in Spanish might end with a "d"), is a [public consortium which aggregates assets](#) from municipalities and provide services to them.

In 2013 we are hoping to convince the public authorities to be reasonable in linking our Traffic from Gurb North to Barcelona. When we look at business models, here is what we see. When the project is new the private company invests and takes its profit from the local economy. When it grows older, investment decreases, cost to the users go up and even more money is removed from the local economy.

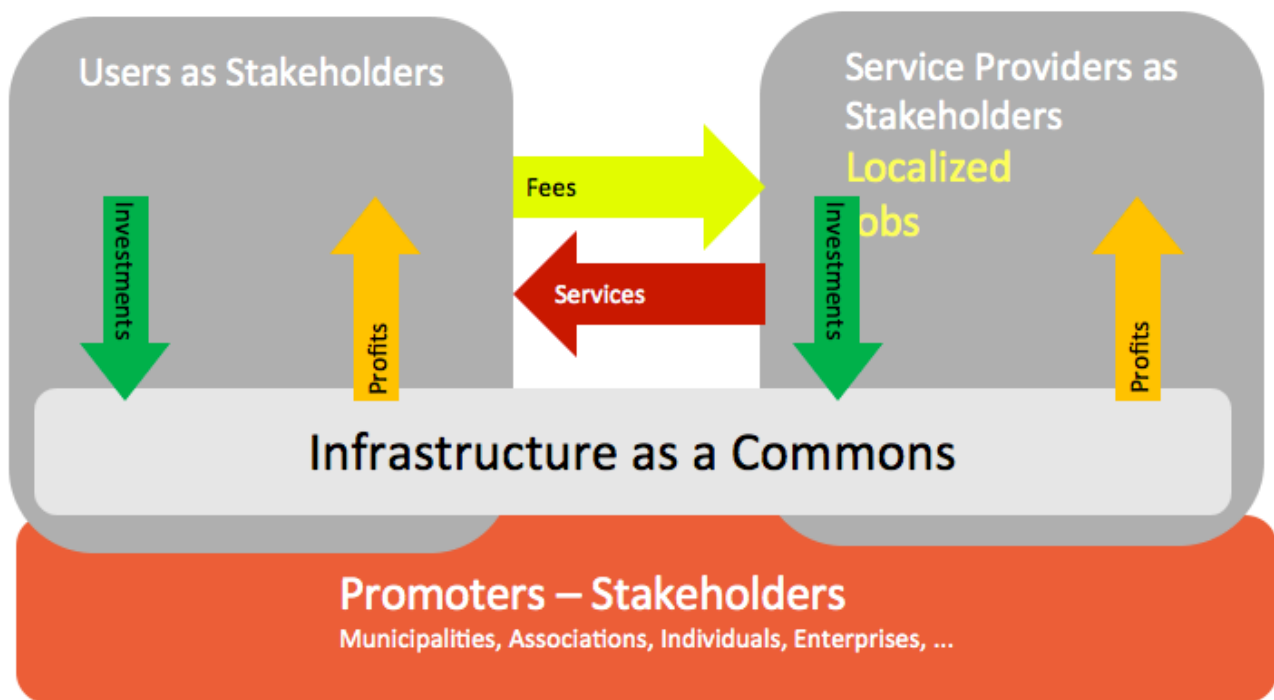

Under guifi.net's commons based ownership the results look like the above. The locality is far better off. Jobs and services and investment stay local.



## Network Architectural Tools

**COOK Report:** What are the requirements to be a zone? How does one find the services that each zone offers? Does each node have to install its own internet proxy in order to get people to an internet gate way?

**Roca:** Formally, the only requirement for running a new zone is to define a page on our web applications linked to a geography (i.e.: "Catalonia"). Then a zone can become a part of a flexible hierarchy, starting from the "World", and drill down up to a region, county, city, village or neighborhood. You just need to tell the app to which other zone every zone is related to. Everybody can define "zones". In short there only needs to be someone with the aim of running a zone.

But to become a truly active and operative zone, I would say that several things have to happen like having Internet gateways available, alternatives for connecting homes (either fibre or wireless), along with what I call the "three pillars" (participation from citizens, local administrations and professionals providing services....) All this is shown on the [Vic Osonaguifi zone page](#) directly below and extending for the full following page marked at the top osonaguifi. The multi colored diagram (lower right) has a live link and show the boundaries for each of the eight neighborhoods of Vic that are also listed as zones under the chart "Vic nodes" on the next

Home > Main menu > guifi.net World > Europe > Iberian Peninsula > Catalunya > Osona > Vic > (Vic-1-NO > Vic-2-N > Vic-3-Ctre > Vic-4 SO > Vic-5 SE > Vic-6-S > Vic-7-NE > Vic-8 Gxa)

### Vic

availability data map networks nodes pending/review services suppliers users  
queue

created: Mon, 01/08/2005 - 22:10 — lluis.dalmau - updated: 17/08/2012 - 4:07pm





zone information

zone name	Vic - Vic
homepage	<a href="http://osona.guifi.net/">http://osona.guifi.net/</a>
default proxy	5735-Vic, proxy-ausa
default graph server	6558-Vic-3 (Centre) Casc Antic, Eixample Morató, Verdaguer, GraphsAusa
network global information:	
Mode	Infrastructure
DNS Servers	10.138.160.98,10.138.0.2
NTP Servers	10.138.160.98,10.138.0.2
OSPF zone	
Time zone	(GMT+01:00) Gurb, France, Germany, Italy

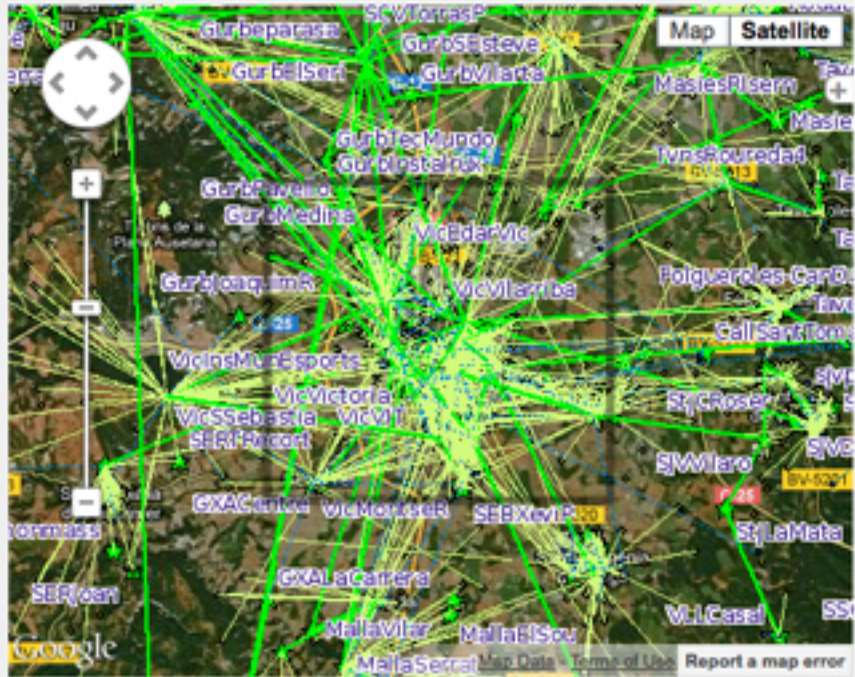

contact information

created by: webmestre at 01/08/2005 - 10:10pm - managed by: iluis.dalmau - updated by: vicmartirs at Fri, 17/08/2012 - 16:07

zone statistics

Nodes listed at Vic

Zone name	Online	Planned	Building	Testing	Total
Vic-1 (NO) C.Planes,Sucre,T.Frares	124	66	1	1	192
Vic-2 (N) Gurb, Sta.Clara, Pol.Nord	224	95	3	6	328
Vic-3 (Centre) Casc Antic, Eixample Morató, Verdaguer	206	108	10	5	329
Vic-4 (SO) Remel, Montseny, Can Robert	112	50	1	4	168
Vic-5 (SE) Estadi, Horta Vermella	144	57	1	3	206
Vic-6 (S) Santa Anna, Plaça Osona, Sanferm	87	20	2	1	110
Vic-7 (NE) Caputxins, St. Llàtzer, Quatre Estacions	151	76	7	3	237
Vic-8 La Gulxa	56	18	0	0	74
	1.104	490	25	23	1.644

[Login or register to post comments](#) [create mrtg config](#) [guifiproxy](#) [CNML](#) [gml](#) [budgets](#)

osonaguifi

Desplegament de fibra òptica a Vic

més

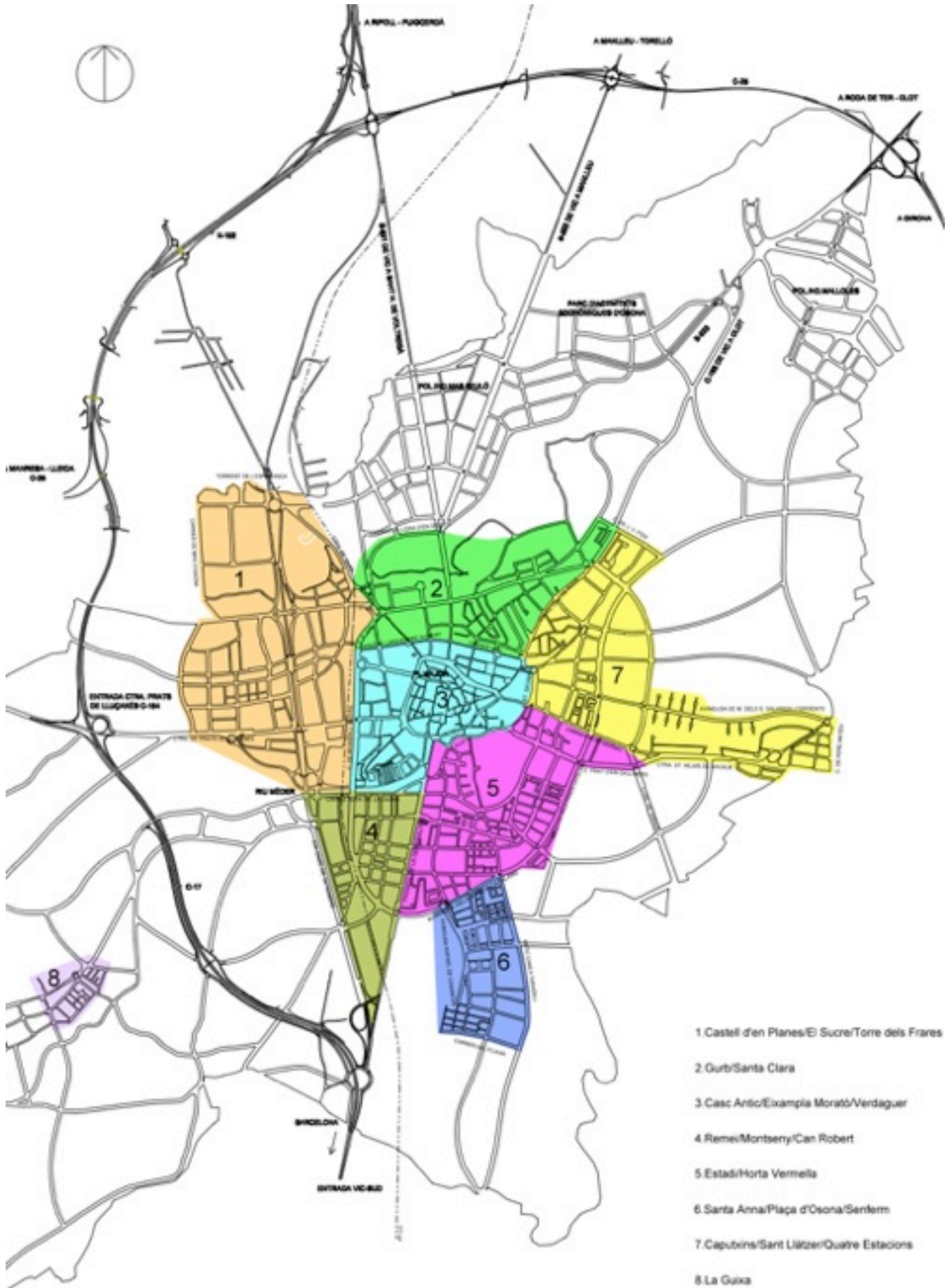



page.

In terms of network services, you can see the available services for each zone at the zone page, by clicking on [the services tab](#) at the top of the Vic osonaguifi page that starts this section. A very truncated screen shot is immediately above. Clicking on one of the eight zones gets you a chart detailing the names location and condition of all nodes there: for

## Vic

availability data map networks nodes pending/review **services** suppliers users queue

### Services of Vic (by zone)

service	zone	device	status	disponibilitat
<b>Asterisk VoIP PBX server</b>				
Servidor VeuIP de Vic	Vic-2 (N) Gurb, Sta.Clara, Pol.Nord	VicLaCentralServer	Dropped	Down (33.04%)
<b>Domain Name Server service</b>				
Servidor de noms a la Guixa	Vic-8 La Guixa	VicLaGuixaServer	Working	Up (93.06%)

### Vic-3 (Centre) Casc Antic, Eixample Morató, Verdaguer

availability data map networks nodes pending/review **services** suppliers users

created: Sun, 17/01/2010 - 20:19 — cesc.cex - updated: 17/09/2011 - 5:14pm

#### Vic



#### zone information

zone name	Vic-3-Ctre - Vic-3 (Centre) Casc Antic, Eixample Morató, Verdaguer
homepage	<a href="http://osona.guifi.net/">http://osona.guifi.net/</a>
default proxy	Take from parents
default graph server	Take from parents
network global information:	
Mode	Infrastructure
DNS Servers	
NTP Servers	
OSPF zone	
Time zone	(GMT+01:00) Gurb, France, Germany, Italy



#### contact information

created by: cesc.cex at 17/01/2010 - 8:19pm - updated by: MiquelM at Sat, 17/09/2011 - 17:14

zone statistics

### Nodes listed at Vic-3 (Centre) Casc Antic, Eixample Morató, Verdaguer

nick (shortname)	supernode	area	status
VicHabitat	11	Hàbitat Catalunya	Working
Vicdalmau	7	Jaume I, el Conqueridor	Working

example Vic-3 the Center Zone shown in turquoise on the page above this one.

**COOK Report:** what can you do when just on a node? Local email only local? What about VoIP or other kinds of service?

**Roca:** When you become a connected node, you can access to whatever service available to the network you joined. The Commons P2P agreement strictly forbids limitations on that. Typically you would enjoy some public and private Internet gateways, as well as some others. VoIP is another example of



popular service when the infrastructure provides enough reliable QoS.

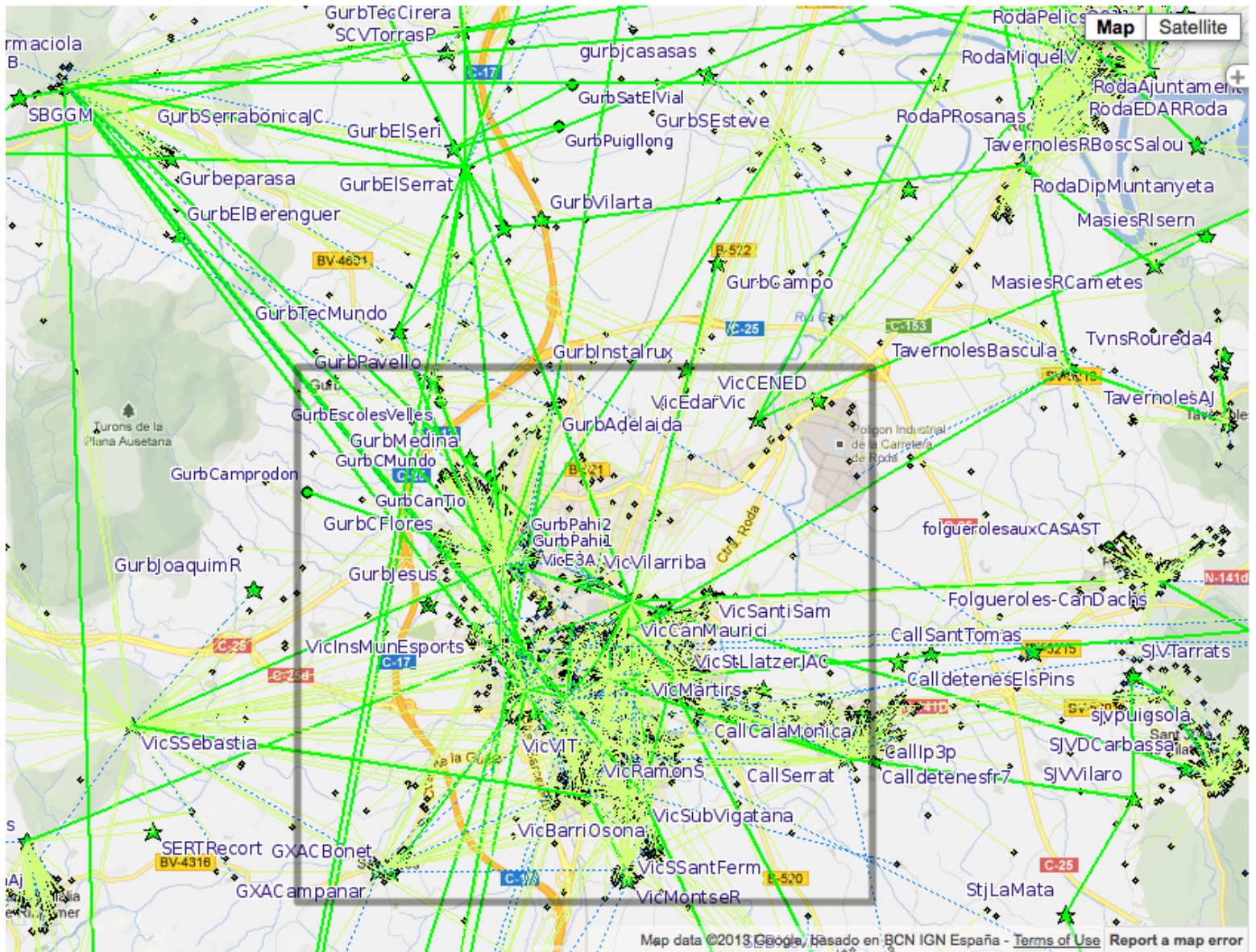

The map above comes from the map view of [Nodes listed at Vic zone 2](#) and shows yellow highway C17 near the top where Ramon and his neighbors laid the fiber discussed earlier.

**COOK Report:** What is necessary to run Skype and communicate like you and I are communicating? I would like to understand better what the proxy link does.

**Roca::** Skype can run both under direct gateways or public proxies. In my case I'm already using the direct gateway through fibre, and is a Gigabit gateway, so that means that there is no problem on running video conference with high resolution. You can do whatever is technically possible depending on the gateway characteristics you use.

**COOK Report:** again it looks like you don't offer commercial television which is good.

**Roca:** Network neutrality is in the core of our Commons P2P agreement, consequently people are free to enjoy whatever content is available to the networks. With the new IPTV providers and SMARTTV, people is free to access the provider they want. Unfortunately in Spain, and also in Catalonia, the TV has been very much still either aerial (now digital terrestrial) or satellite, but not very much on cable, so we lack very much from local TV providers, however we can already enjoy things like Apple TV, or recently some interesting devices based on Android are appearing.

**COOK Report:** Is Spain addicted? In Catalyunia does a Cable TV company offer services? Telefonica ? Does it come bundled with internet service? How many subscribers to guifi.net also get TV?

**Roca:** As for Spain - Sure we are addicted to TV. I assume like any other part of the world. However neither here in Catalonia, nor in Spain, do we have Cable TV providers in the same way as you have in the US. TV is mostly aerial, with the limitations that this inherits. With IPTV operators are now bundling their TV platforms with a "triple play" strategy, so if you get broadband form them, you can get also their TV, but not that content from anyone else. We don't like this bundling strategy, and keep the users free from choose the multimedia provider of their choice. Due to the limitations of wireless, I would say that just a few percentage of users from [guifi.net](http://guifi.net), like myself, can enjoy high definition TV. Only those who have fibre in their homes. Others can just access TV at a low-res.

**COOK Report:** Is Telefonica the only commercial internet provider in all of Catalunya?

**Roca:** Telefonica as national incumbent is the only operator who has a network for that. Some other operators have some networks, but far from covering all territory. However the current regulations forces Telefonica to rent their networks to other operators, so commercially, other companies can also provides their services through Telefonica network (now mostly copper), that's the case of Jazztel, Orange, Vodafone...

**COOK Report:** what kind of phone service do you have? Did anyone offer commercial phone service?

**Roca:** Currently, once you have a NGN broadband service, Internet has already plenty of VoIP providers who can give you cheap services. I'm currently having two or three of them.

**COOK Report:** if you have full fledged internet access at POPix..... thy is there a need for anyone to run proxies from or for anyone or thus?

**Roca:** We don't have fibre gateways everywhere, and just from wireless, the closest gateway in many cases might still be a shared aDSL. On the other hand, to enjoy a the full fibre gateway, you have to contribute to it's cost. By sharing the costs once you get some critical mass, is not a high cost, but you still have to share the cost. Some people might just want internet for free, so they can still get that from public proxies available from public libraries etc., so proxies still make sense. When possible, those proxies already run on fibre, but still not all of them.

# Adding Zones and Nodes in North America

**Roca:** Now that you have given yourself a user ID on the guifi system, you can login and create content and I as administrator have privileges that I can use for teaching purposes, to also create content in order to impersonate you . So let's do that. You can see here the menus you have available. Go to guifi.net World and then to America and then to the United states, then New Jersey, and finally Ewing. Thus

The screenshot shows the 'guifi.net menus' page. The top navigation bar includes 'Languages' (English, Asturianu, Euskara, Català, Français, Galego, Português, Castellano), 'User login' (Username: Gordon Cook, Password: \*\*\*\*\*), and 'Log in'. The main content area is titled 'guifi.net menus' and contains several sections:

- Statistics**: A section for viewing statistics.
- History map**: A section for displaying the guifi.net network history map.
- Node statistics**: A section for viewing node statistics.
- Data to review and Pending actions**: A section for cleaning and reviewing the database and taking appropriate pending actions.
- Availability report**: A section for reporting the status and availability of all nodes.
- Node queue**: A section for tracking the status of not active nodes, pending for getting connected.
- Users queue**: A section for tracking the users assigned to nodes detected as active, and therefore pending for approval.
- Main navigation options**: A section for the most important options to browse and use the site, including:
  - Proposals, Budgets & Fundings**: Browse proposals/budgets, find costs, and help with funding.
  - Service providers & Commercial suppliers**: Find shops for equipment and professional services.
  - Browse the network**: Browse network zones starting from the root zone.
  - Create a node**: Join the network by creating a node.
  - Documentation**: Browse the guide and documentation.
  - FAQ**: Browse the most common questions.
  - Forums**: Browse questions or post your own question.
- IP and Network management tools**: A utilities toolset for network addressing and management, including:
  - Search IPv4**: Query information about assigned IPv4 addresses.
  - Available subnetwork range**: Search for unused network address ranges.
  - Search MAC**: Query information about existing MAC addresses.

On the left side, there is a sidebar with a search bar and a 'proposals' section. Below that is a 'network figures & facts' section with a table of node statistics:

Nodes	30.301
Working	19.393
Planned	9.893
Testing	534
Building	369
Reserved	98
Dropped	14

Below the table is a 'Wireless links' section with a table:

Wireless links	#	kms.
ap/client	20.353	26.264,30
PtP link	2.039	8.965,30
unknown	1	0,20
<b>Total</b>	<b>22.393</b>	<b>35.229,80</b>

At the bottom left, there is a 'Nodes operatius' section with a line graph showing the number of nodes over time.



# guifi.net World

[availability](#)   [data](#)   [map](#)   [networks](#)   [nodes](#)   [pending/review](#)   [services](#)   [suppliers](#)   [users queue](#)

created: Sun, 15/01/2006 - 18:04 — rroca - updated: 23/09/2011 - 3:05am

This is the root page of the guifi.net mesh network. From here you can drill down to obtain any detail of the network nodes and services. This application provides a set of functions for supporting wireless communities such as mapping tools, availability and bandwidth usage graphs, network ip allocations, configuration tools, user forums, etc. If you wish to join guifi.net network and extend this root zone, just do it: This has been built on open source and supports multi-language.



## The Americas Zone





### The United States Zone

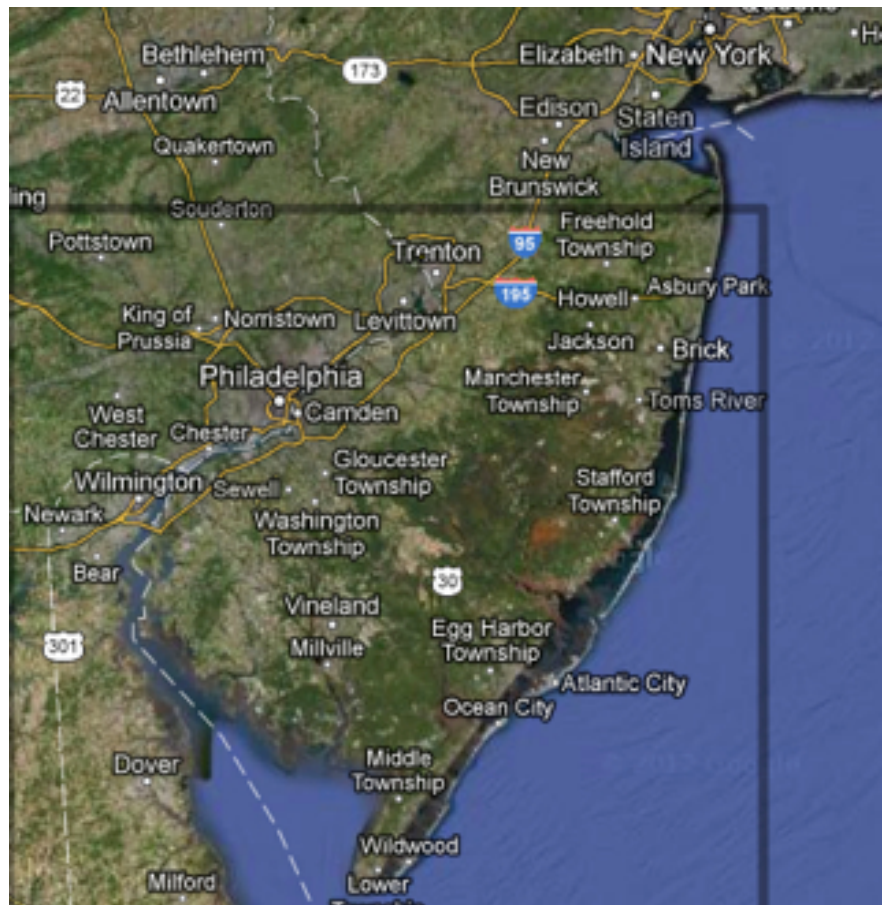

### New Jersey Zone

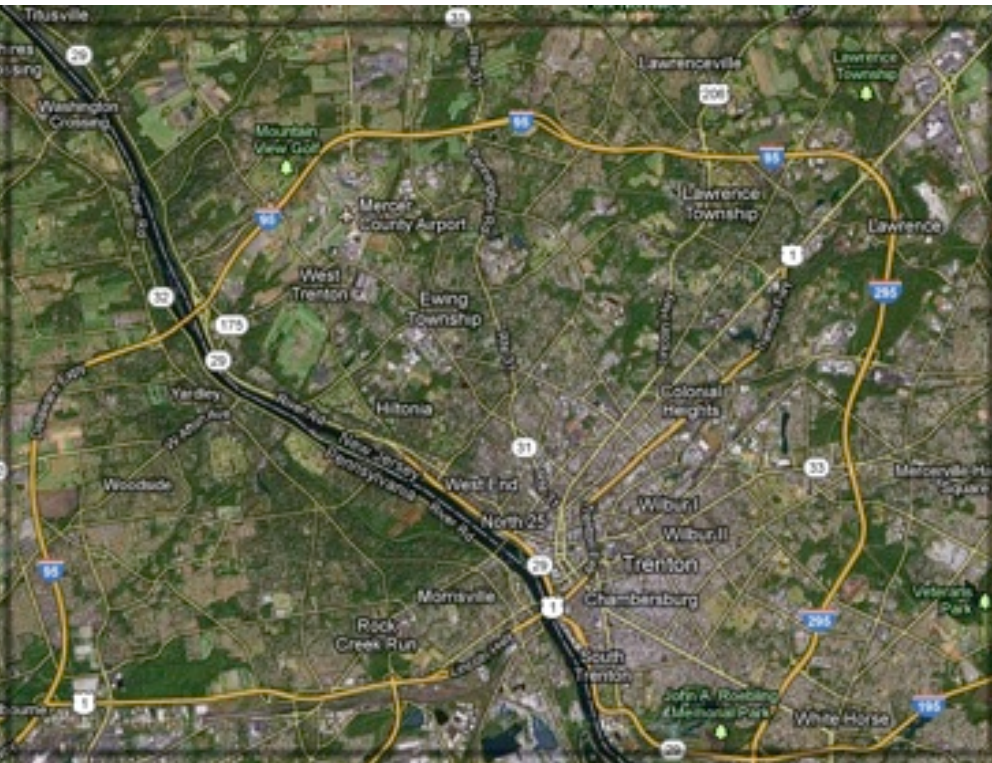





Above are two views of the NJ zone and below of the Ewing Zone. At the lower right is my house - marked EW.GCook. Once one is situated with a bird's-eye view of my house, point the mouse at my chimney, click and the precise latitude and longitude of my node comes up and the software asks

Home > Main menu > guifi.net World > America > United States of America > New Jersey > Ewing

## Ewing

[availability](#) [data](#) [map](#) [networks](#) [nodes](#) [pending/review](#) [services](#) [suppliers](#) [users queue](#)

created: Thu, 03/01/2013 - 17:51 — rroca - updated: 03/01/2013 - 5:51pm

### zone information

zone name	Ewing - Ewing
default proxy	Take from parents
default graph server	Take from parents
network global information:	
Mode	Infrastructure
DNS Servers	
NTP Servers	
OSPF zone	
Time zone	(GMT-05:00) Eastern Time (USA & Canada)

### contact information

created by: rroca at 03/01/2013 - 5:51pm



zone statistics

## Nodes listed at Ewing

nick (shortname)	supernode	area	status
EW.GCook	No		Planned

[Login or register to post comments](#) [create mrtg config](#) [guifiproxy](#) [CNML](#) [gml](#) [budgets](#)

me to name my node which I choose as EW.GCook or "Ewing zone Gordon Cook" and the close up view looks as at the left. The page Ewing Zone above, nodes listed gives information about the Ewing Zone. The line of text below Ewing gives availability, data, maps networks, etc all relating to activity in the Ewing zone. The tools have created a template for me that I may use to map my locations.

Next we tell the software where the back bone node I will connect to will be. I suggest to Ramon a radio in the bell tower of Ewing High School about 30 odd meters in elevation. The software uses google maps to calculate the capability of the radio I will need to install and offers me choices of Microtik and Ubiquity to install to have good signal to the high school backbone node some 800 meters away. When I save the page, its asks me to agree on your behalf that you will accept the licensing as infrastructure owned in commons and the it wants the height of your antenna. We will say 10 meters.

The screenshot shows a web browser window with several tabs: 'visitades', 'Release Notes', 'Fedora Project', 'Red Hat', and 'Free Content'. The main content area is titled 'Radio main settings (SSID, MAC, Channel...)' and contains the following sections:

- 1 radio**
  - Radio #0 - ap - EwingWGckRd1AP0 - 2 interface(s)**
    - Protocol:** 802.11b (1-11Mbps - 2.4Ghz) (Select the protocol where this radio will operate.)
    - Channel:** Auto 2.4GHz (Select the channel where this radio will operate.)
    - Clients accepted?:** Yes (Do this radio accept connections from c...)
  - Antenna settings**
    - Type (angle):** sector\_120 degrees (Angle (depends on the type of antena you will use))
    - Gain:** 14 (Gain (Db))
    - Degrees (°):** 0 (Azimuth (0-360°))
    - Connector:** Main/Right/Internal (Examples: MiniPci: Main/Aux; Linksys: Right/Left; Nanostation: Internal/External)

Now we have selected the radio and must configure it. If from the high school, you click on your house, and get a yellow line between the two, it means that it is line of sight between the 2 points. You will now be one of those tiny yellow circles you saw on the maps, a planned node and not yet a real part of the network. This tool helps in two ways. ***It declares you as willing to participate in the network so neighbors can see who is willing and how close others are to them.*** And this tool also helps you to plan the network. It is just one of a very large number because we have to make network planning of nodes and backbones speedy and precise. For planing long links of 10 to 50 kilometers, this tool will let you know how the terrain varies. Namely ground level, hills valleys and so on. When doing short links, your line of sight must be from a point on your house that will clear the tallest tree between you and the high school.



## More about Node Placement



I can do a better job of showing you how this works by going to the node at my home and

node	1568 GurbEISerrat	GurbEISerrat
zone (mode)	Gurb (infraestructura)	Gurb-Nord
posició (lat/lon)	Lat:41.974191 Lon:2.238115	0 metres des del terra
disponible per fer xarxa i monitoritzar	Yes	<b>Operatiu</b>
gràfics proveïts des de	6833-Gurb, GraphCecilia	

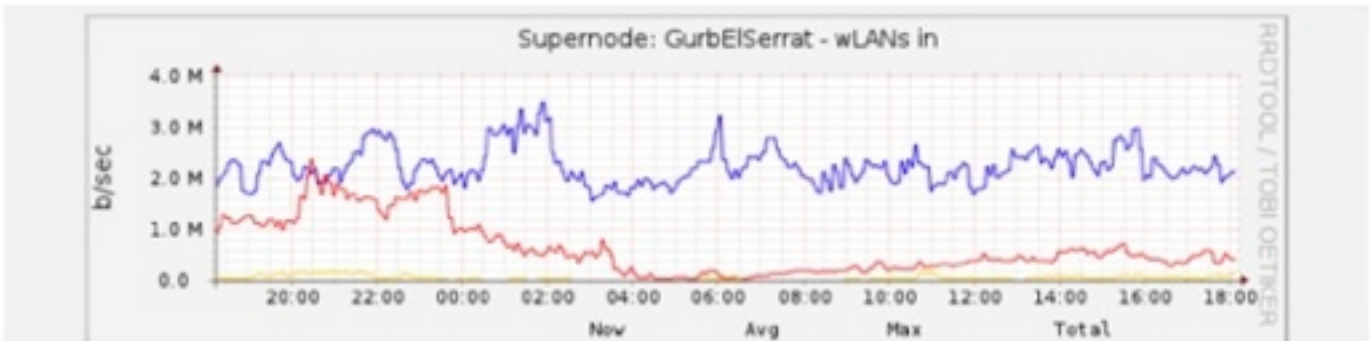
**informació de contacte**  
 adreça de correu electrònic (disponible si estàs identificat a la web) - creat per: webmestre a 15/09/2004 - 11:00pm - actualitzat per: rroca a Dij, 04/09/2008 - 16:40



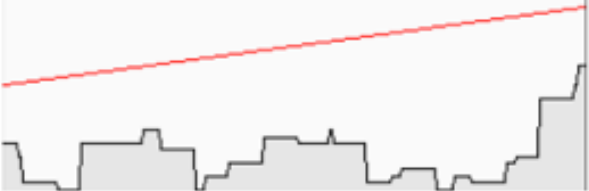

showing you the links and the traffic. The red and blue lines on the graph below the picture of my node show the average bits per second traffic coming in and going out through

<p><b>GurbTecMundo:</b> Gurb</p>	<p><b>1.687 Qms:</b> Working (03/03/2012) 202º - Sud</p>	
<p><b>GurbPavello:</b> Gurb</p>	<p><b>2.057 Qms:</b> Working (13/01/2007) 189º - Sud</p>	

**GurbAdelaida:**  
Gurb

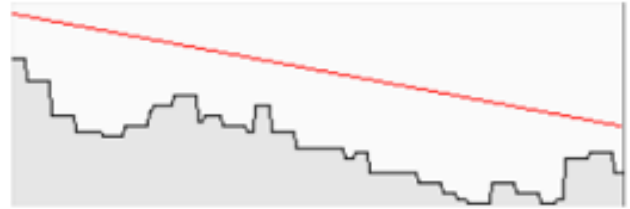
**2.452 Qms:**  
Working (06/05/2009)  
160° - Sud



**gurbjcasasas:**  
Gurb

**2.486 Qms:**  
Working (04/06/2009)  
69° - Est

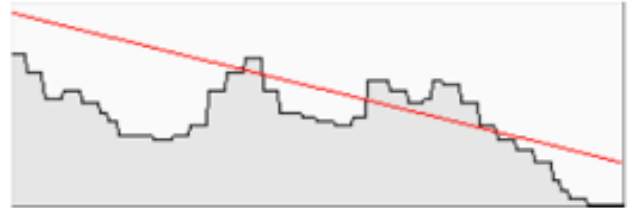

my supernode which also has a fiber connection. Another tool will show you the nodes with whom you can easily collect along with the terrain the location on the 360 degrees of the compass and the distance away. We are very proud of our tool set. This demo shows you maybe 5 to 10% of our existing tools. But let's go back to your node.

Now imagine that we want to put a wireless device on your roof. Therefore in the system I want to add a wireless device. Now from the list it gives us let's tell it we want a good powerful nano station. So when I choose the device the system gives me the screen below for configuration. Now on the next screen I give it a mac address - a fake one - save and exit.

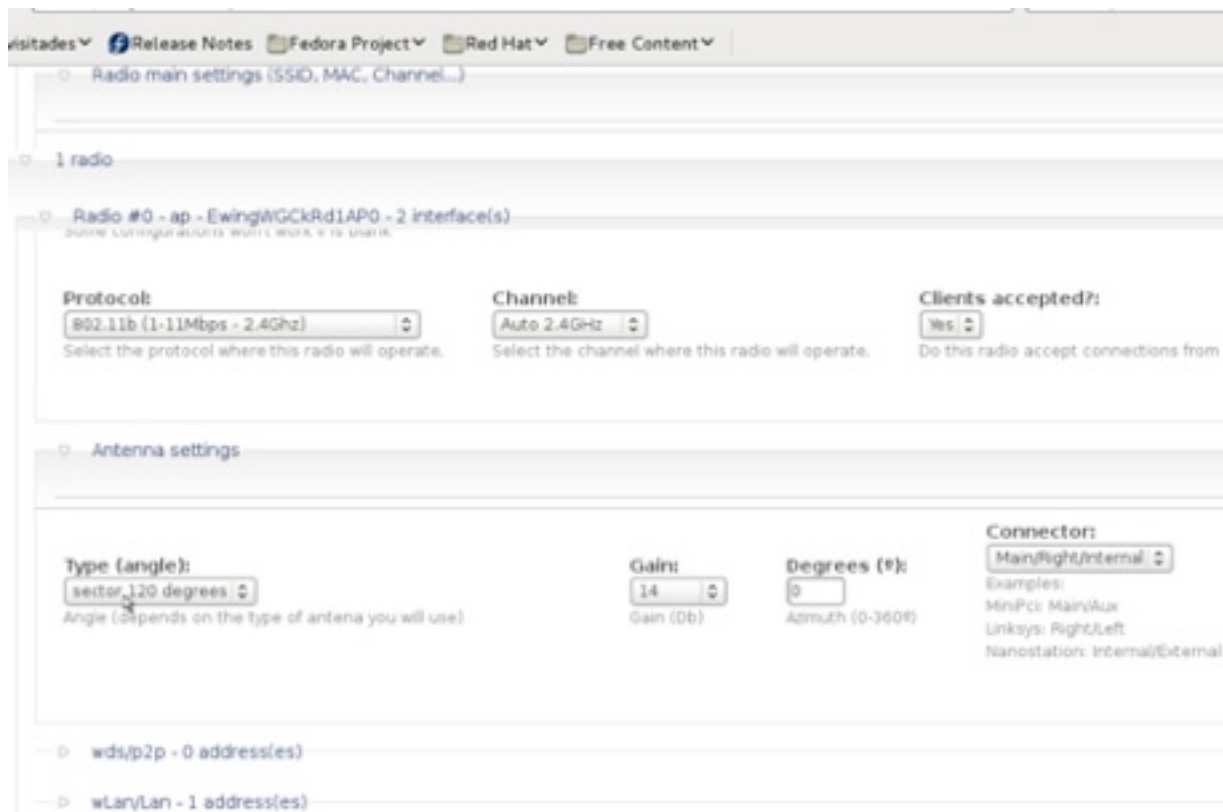

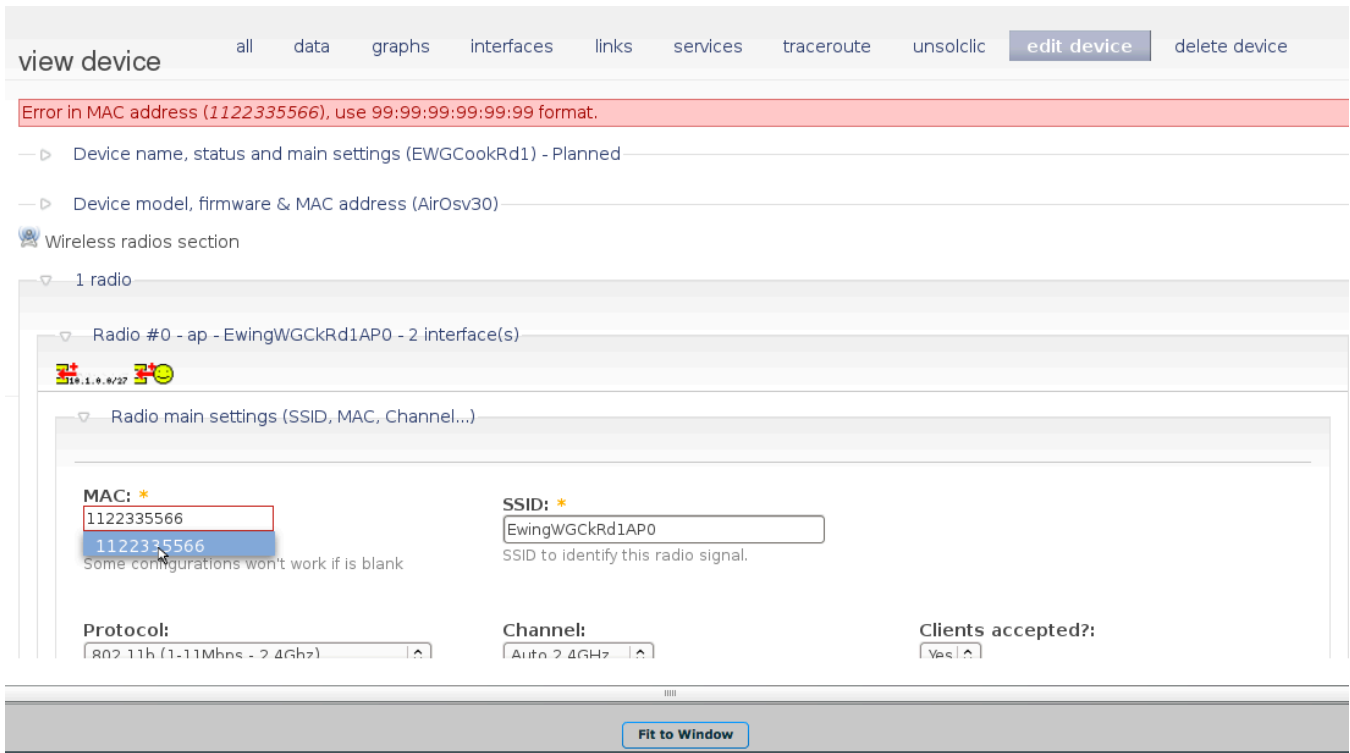

**COOK Report:** And if I had the radio in front of me, I could give your system the real address. Yes?

**R o c a :** Yes indeed. Right now the radio-device is not capable of being a client because you still have no radio at your high school. Still it could function as an access point. Therefore I will use the software to "add" add a new radio. Doing that does a lot of things for me. It will show me the mac address, we tell it what kind of antenna we will use and the 360 degree orientation of the

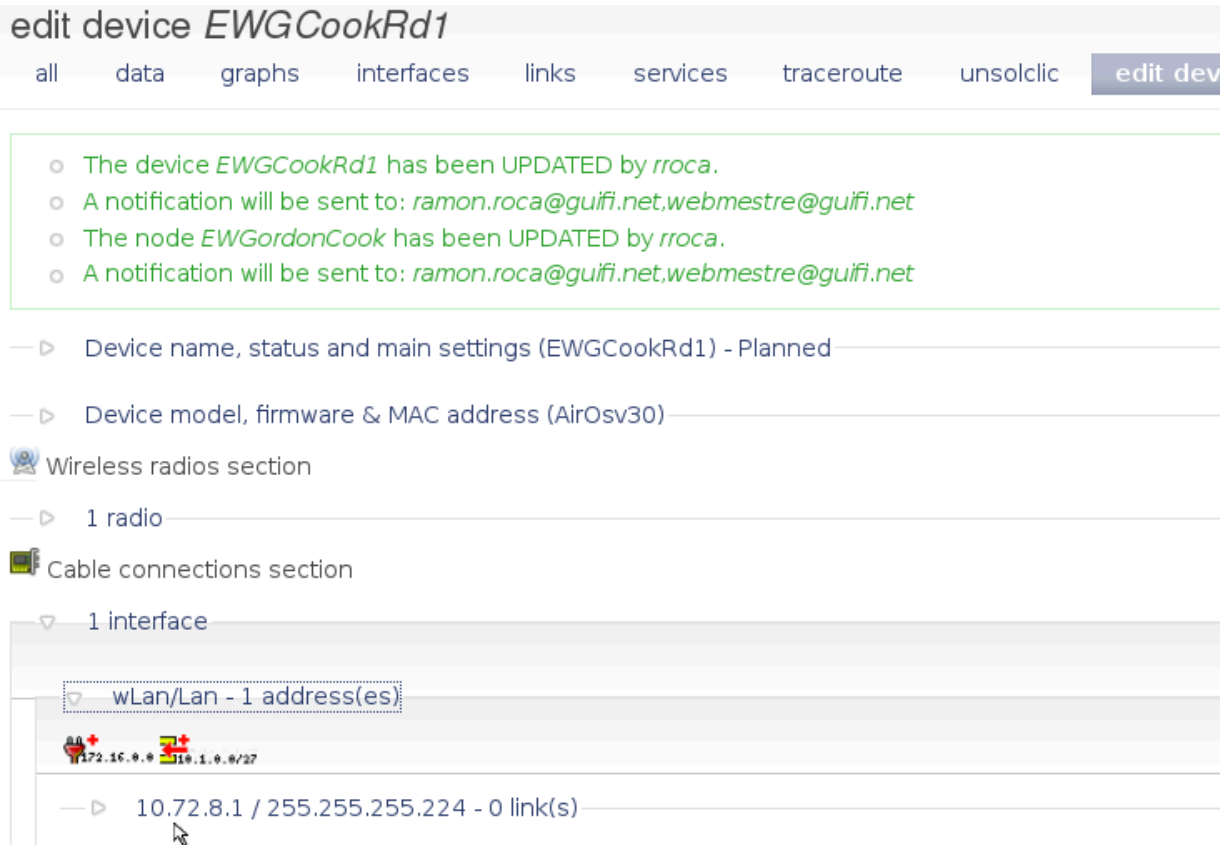



antenna. Now I will save it. And something very important to understand is that we have an IP address of 10.72.8.1 as you can see where the cursor is at the very bottom of your screen shot. This IP number and its net mask that the system shows you will be unique across all the world in which guifi.net is setting up these devices. It uses netblock 10 that globally is designed for "natted" unannounced back bones. Doing it this way means that we control our own global hierarchy and that you, without being an administrator, can set up in such a way that you fit into our network hierarchy and that one day a gateway to the internet can be established for you from those addresses. In addressing there is also IPV6 as a consideration that we are working on.

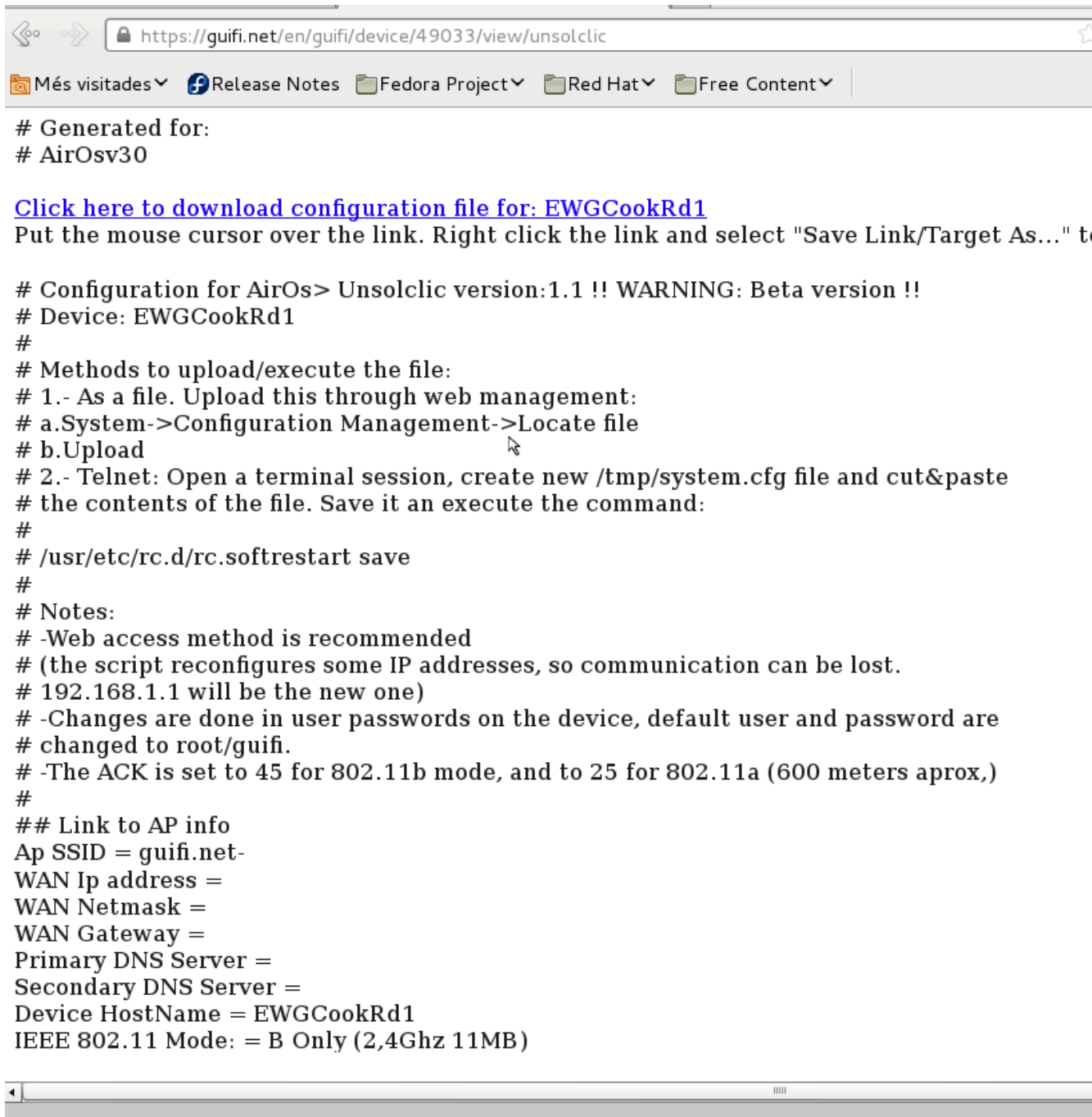

```
# Generated for:
# AirOsv30

Click here to download configuration file for: EWGCookRd1
Put the mouse cursor over the link. Right click the link and select "Save Link/Target As..." to

# Configuration for AirOs> Unsolclic version:1.1 !! WARNING: Beta version !!
# Device: EWGCookRd1
#
# Methods to upload/execute the file:
# 1.- As a file. Upload this through web management:
# a.System->Configuration Management->Locate file
# b.Upload
# 2.- Telnet: Open a terminal session, create new /tmp/system.cfg file and cut&paste
# the contents of the file. Save it an execute the command:
#
# /usr/etc/rc.d/rc.softrestart save
#
# Notes:
# -Web access method is recommended
# (the script reconfigures some IP addresses, so communication can be lost.
# 192.168.1.1 will be the new one)
# -Changes are done in user passwords on the device, default user and password are
# changed to root/guifi.
# -The ACK is set to 45 for 802.11b mode, and to 25 for 802.11a (600 meters aprox,)
#
## Link to AP info
Ap SSID = guifi.net-
WAN Ip address =
WAN Netmask =
WAN Gateway =
Primary DNS Server =
Secondary DNS Server =
Device HostName = EWGCookRd1
IEEE 802.11 Mode: = B Only (2,4Ghz 11MB)
```

Now we developed our netblock 10 advertising before we joined RIPE and gained access to public IPv4 blocks. The use of this netblock 10 IPv4 "natted netblock" does not yet incorporate IPv6 but what it does do is this: When I click on the "install" option the system gives me all the configuration information for the "virtual" radio we have just installed.

This is the kind of screen you run on the device that describes everything. There is no need for manual configuration of new radios because when you are running a network like this. It is much better to have new devices for people that self configure through a few easy steps rather than force people to type in into a web interface a long series of entries each of which must be precise for the system to work.

***Networks across the world are facing issues like this and this is why it makes sense to cooperate with each other so that each new community does not have to do this as part of a time consuming wheel reinventing process.***

**COOK Report:** Well what would Isaac have to do to be able to use in Kansas City the tools that you have developed?

**Roca:** One of the questions that I have already gotten from Isaac is where is the source code of all this? I will see that he gets its because we are more than happy to have others hacking on and improving what we have already developed. This is not the end of the story it is just the beginning.

**COOK Report:** So long as a 3<sup>rd</sup> party's uses what you have developed in accordance with the rules of open source they are perfectly welcome to regardless of whether they are directly affiliated with you in any way?

**Roca:** Yes. We developed our rules of infrastructure owned as commons quite early on and since we purchased the fiber in 2009 we haven't done much more development while we are working on getting the necessary interconnection approvals. But I am already thinking that the next generation of this should be written from the point of view of wireless plus fiber in the development of Bottom up Broadband.

**COOK Report:** When at the end of 2012 you had the Wireless Broadband World Congress in Barcelona and Sasha Meinrath was a major organizer, did he react well to the code that you have prepared? Did he say anything like "oh boy I know so-and-so in the US who really needs to see this and will probably want to use it"?

**Roca:** I am not sure that Sasha has actually seen these tools that I have just shown to you and by way of self-criticism I might say that our various communities are not as good as they should be in sharing the tools that they develop.

**COOK Report:** Okay I would really like to help and one of the ways I could do so is to explain what you've done in such detail that it will become obvious to readers who are not aware of you as I was not aware until recently. As many people as possible should understand that guifi.net entity exists and furthermore that it is a system that goes an order of magnitude beyond the capabilities of any system that I have ever seen and I strongly suspect that my readers would have the same reaction. It seems to me that you can do everything the incumbents can for a much cheaper price.

**Roca:** We believe that is true.

**COOK Report:** And considering the very bad situation we have here - in the USA - I personally would like to see you to replace the incumbents.

**Roca:** We believe we would get further faster with the local political administration if we put it differently and said "look why don't you let us compete with the incumbents? If we can do what we believe we can, we will become an alternative to them and rural areas offer services that they cannot. Surely it is time to give the local people a choice?" Also it helps us to stay on better terms with the European Community authorities.

**COOK Report:** Why don't you put it this way and say to the authorities that, while there may be some pieces of content that the incumbents could offer that you would have a hard time matching on that from a technology point of view there would be little if anything that the incumbents could do that you could not do. Is that a fair appraisal?

**Roca:** Yes. And for just providing Internet access we don't need the incumbent at all.

**COOK Report:** But I think what you are also saying is that it is much better not to become a target to the incumbent or the authorities unless you absolutely must.

**Roca:** Yes.



# Treasures everywhere

**Cook Report:** As I continue to work on the retelling of the guifi.net story I discover many fascinating new tools guifi.net here is one such tool. This page was gotten by [this url](#). The map is for planning line of sight connections between nodes and can show the would be user what will work and what won't. Turning on contours give a much better idea of the topography involved, These pages use material

Home > Main menu > guifi.net World > Europe > Iberian Peninsula > Catalunya > Baix Empordà > Platja d'Aro > Platja d'Aro - Dipòsit Cim d'Aro > (PdADiposit-H&I > PdADiposit-P&L&T&Z > PdADiposit-L&A&F&R > PdADiposit-S&P&R&P > PdADiposit-P&L&S&R&I > PdADiposit-M&I&S > PdADiposit-AP-N > PdADiposit-AP-S > PdADiposit-AP-E > PdADiposit-AP-O > PdADiposit-AP-NS)

distances map from PdA-PdADiposit

data devices distances graphs links profiles map services users

Click on the map to get a new path profile ( Thanks to HeyWhatsThat ) to check the Line Of Sight  
Click on the path profile to see the point on the map

Profile graph and Countour Layer provided by: HeyWhatsThat Copyright 2012 Michael Kosowsky. All rights reserved  
Visit HeyWhatsThat WISP for tools for planning wireless networks.

Distance: 68.952 Km. Azimuth: 290.53 degrees

from [this site](#) as well. The next discovery I made was [here](#).

Now when you arrive at this target you see the mailists for the osona region which covers the areas of Vic and Gurb. Here is the landing page on which you may find out about optical fiber laid to a summer camp for teenagers in vic where the kid were taught how to lay the fiber. Next is a list where users are informed that the supernode VicPalau Bojons is down. Money for the repair is being crowd sourced by the list as well as a schedule that people sign up for a schedule to go out and to install new equipment.



[bloc](#) [guifi.net](#) [la gent](#) [la xarxa](#) [els continguts](#)



[DIVULGACIÓ](#) [AGENDA](#) [CONVOCATÒRIES](#) [MILLORES](#) [MANTENIMENT](#) [APADRINAMENTS](#) [TÈCNIC](#)

### Desplegament de fibra òptica a Vic

Aquest estiu, durant el camp de treball, es va començar el desplegament de fibra òptica per connectar l'Escola Andersen, el Club Pati Vic, l'Alberg Canonge Collell, el Mas Osona i l'Estació Meteorològica.



A l'agost vàrem fer una primera connexió provisional entre l'Escola Andersen i el Club Pati Vic. Al setembre s'ha construït la canalització soterrada que va quedar pendent per connectar els esmentats edificis i aquests dies es finalitza aquesta construcció.

Hem previst que el **dissabte, 10 de novembre**, a partir de les **9 del matí**, ens trobarem davant l'Alberg per realitzar el **desplegament del cablejat de fibra òptica** i connectar els edificis.

Et convidem a participar en aquest desplegament de xarxa oberta, lliure i neutral, xarxa de comuns, amb fibra òptica: veient-ho, ajudant-hi, documentant-ho, ...

**Apunta-t'ho a l'agenda !**

admin | dv. 26.10.2012 | Divulgació

### Reparació supernode Vic Palau Bojons

**Apadrinament Obert !**

<http://guifi.net/ca/node/49608>

admin | dv. 29.06.2012 | Apadrinaments oberts, Incidències

### Primers trams de fibra òptica a Vic

Fa temps que s'està treballant en diversos projectes de desplegament de trams de fibra òptica guifi.net a Vic, això mateix està passant a altres poblacions de la plana, com Gurb, Centelles, Calldenes, entre d'altres.

En el cas concret de Vic està previst fer trams que connectin diferents supernodes entre ells per tal de millorar la xarxa i permetre donar capilaritat a aquests primers trams per poder fer arribar fibra des de qualsevol dels edificis veïns d'aquests supernodes.

admin | dg. 06.05.2012 | Millores, mèe Xarxa

Formulari de contacte

@ llista de correu gvíc

**guifi.net**

la xarxa a osona

xat guifi.net

fòrum guifi.net

cartell informatiu [linuxer\\_carde10](#)  
 en venda ubicat nanostation de 5GHz [mikyr](#)  
 Ajuda connexió client-AP [linuxer\\_carde10](#)  
 No trobo el proxy per a La Mata de Morella [electrificacioneslamata](#)  
 problemes a <http://guifi.net/guifi/device/869> [Toni-39](#)

altres espais de trobada

notícies guifi.net

Ampliem la interconnexió amb el CATNIX a 1Gbit [roca](#)  
 Xerrada de guifi.net al casal joves Boanord (el Carmel, Bon) [eloi.rebes](#)  
 BattleMesh V6 [p4u](#)  
 El futur és el cooperativisme i el treball en xarxa, [guifi.net](#)  
[Ivís.dalmau](#)  
 Oferta de lloc de treball a la Fundació [guifi.net roca](#)

Usuaris

Avui:	25
Ahir:	89
Abc:	1



# Network Governance

## *The Commons License*

**COOK Report:** Finally, may I ask some questions about the Commons License? How close are you to having a good English translation of the Commons License that includes the changes brought about by were becoming a network with fiber as well as with wireless? How we should characterize the kinds of changes that you have had to make my virtue of becoming a network that uses fiber?

**Roca:** First we took out the word "wireless" from the License because we wanted to be technologically neutral. This means that we have the same agreement for both fiber and wireless. That's one of the points, the next is about managing the infrastructure in a way that keeps me Neutrality and avoids the conflicts that were beginning to appear in real-world practice. There are two kinds of conflicts that tend to arise that the license helps to solve.

Let me give you an example of something that is not written in the language but will tell you in practical terms of what actually the Licensee is useful for. When we have many organizations and communities that are working with the commons network that we are building -- which is one of the goals because we wish to reach the whole world not just a given community. Under such conditions there are two kinds of conflicts that arise that the license helps to solve. Let me give you an example this is not written into the license but it will tell you in practical terms with the license is useful for.

Here is one thing that is important. We have to keep the conditions of network neutrality but we also have to work with people who provide professional services to the network. Things such as installing networks providing service level agreements fixing problems when they arise. From the now these people can charge money for doing so because they are offering professional services. So one of the conflicts that happens is that there are other people who are working on a non-volunteer basis. When they see other people taking what they regard as profits because they are working on the network maybe they become jealous I don't know how to describe exactly what. Some of them can't become upset. And say "oh no you said you were nonprofit but to charge for any services is violating the principles of the Internet."



Therefore it is important to have your charter written in such a way that it makes clear that the network is an infrastructure held in Commons for all but that people can also use the network for business services and provide services to users that they may charge for and so on. Now the other problem is that people who also control the infrastructure. People who are professionals will also at some point be tempted that since they are very much building the infrastructure at some point they will be tempted to control the infrastructure and perhaps fix the prices or say to some friends okay we will give you a special deal or if you want to get connected here you have to be a customer of mine -- things like that.

The commons is a useful agreement to describe the standards that people are expected to follow. And one of the things that became evident was that we had to make clear that the network must remain intact as a commons. Somewhat wonky who wants to improve it for everyone's use by hiring professionals should be able to do so. This is very important and to make a point I will tell you for sure that if you don't have things rather thoroughly written down when conflicts arise as they will for sure, then there will be no way to solve such problems.

If you don't have these strictly enforced comments agreements there you will see them soon it will be, a private network either from the actions of professionals who control the, or from the actions of radicals who are against the use of the network for any kind of business purposes and in such case it will become a network just for geeks. Because he if people cannot hire professionals to build a network and especially for FiberNet works, what does this mean? It means that there is no chance for running a fiber when you have to do such things as cross property boundaries. You will quickly find that the do-it-yourself aspect cannot be 100%.

**COOK Report:** Right but it does show how people can organize on a community basis with a minimal level of expertise and without a significant hierarchy can decide what they want to do and go ahead and do for themselves what has to be done..

**Roca:** Yes. But rules of participation must apply because there are costs and people must agree upon costs and agreed upon when and how they were put forth their money to pay.

**COOK Report::** well I think I can spot an example. You said in passing much earlier that a group of us got together and ordered fiber from China and Medway realize that perhaps that 20 km or so of fiber in the urban area that you showed me more recently and that began to be laid in 2009--was that the fiber you were talking about? Did you and your neighbors literally get together and decide to measure the amount of fiber needed to connect those people to each other and to either other fiber runs or wireless supernodes?

**Roca:** Yes it was done as a group purchase from China by the very people who would be served by it. And the big point here is to understand that some costs of apply and that

the people involved must realize that they won't if they want fiber connections they must participate in financing the purchase and installation of the fiber to connect them. Now once it is deployed, the fiber will be for all of them.

The important thing to understand here is how the costs are split. If you are an incumbent and you build infrastructure like this you own that infrastructure and also the one who is providing the connectivity services. Right? In our model the difference is that the infrastructure is held in, and is not owned by any commercial provider at all and that since that infrastructure is owned by the community any professional is free to offer to provide services that rest on it.

**COOK Report:** And once the infrastructure is laid out, I cannot say "oh great now I will buy 20 meters of fiber to run from the ONT (optical network terminal unit) on the side of my business out to the fiber on the nearest street and be able to connect right there." I cannot say this because, by waiting, I will be able to piggyback on the investments of my neighbors. I must find some way to assess a more fair share of my cost in connecting to the fiber networks that my neighbors have already built?

**Roca:** Yes that is why we have rules about joining the infrastructure. Everyone should be able to join and that is why we work on a cost ace its. You may remember that the cost in this case in solving a build of over 20 km of fiber that connected several dozen users, was €1000. Everybody pays. The same rules apply for everyone and there is no way to get connected to the fiber for free. ***You must join the community and pay for your share of what the infrastructure cost is to the community you are joining.***

**COOK Report:** So do you add it all up then and while the distances between users who join is probably not the same, in each case you take the total distance that the build covers and divide by the number of participants to get an an average cost? Yes? And if someone along the fiber route in the original purchase chooses not to participate, you warn that person that if he decides later he wants to join he can indeed join but it will cost him the sheer cost plus a penalty?

**Roca:** Yes. What is the case is that the amount of fiber doesn't matter that much but making the splices, lighting it, and managing are the significant expenses - so we divided by all the houses who want to join and to avoid people taking a speculative position and say we will wait a year and see what happens.

When we say to them do what you want, but if you want to join later you must in effect contribute a full share of the original cost plus a penalty of 50% of the share cost and so in a case where a share cost €1000, that same share a year later, if you decide to wait, will cost you €1500.

## **Part 2 FreeNetwork Foundation**

### *DIY Commons Infrastructure in the US*



# FreeNetwork Foundation Launches Kansas City FreeNet

## *A Continuing Report May 2012 through January 2013*

**Editor's Note:** What follows are interviews with Isaac Wilder from October 22 and 25 2012 and January 19, 2013

**COOK Report:** When we last saw each other it was at David Isenberg's Freedom to Connect conference in May, and you were getting ready to attend a number of other conferences. How would you describe the direction in which you were headed when we last met? I am thinking of what you had in mind other than the intention to continue technical development and attend some meetings? When did KC get finalized? Or was it always Kansas City?



**Wilder:** It wasn't always Kansas City, but, by that point, it had been decided. I actually came East to that meeting from Kansas City. I had left New York in mid March and gone back to KC. I had basically been sleeping on my friend's floor for eight months at that point, and I realized what I wanted to do was

going to take a bit longer than I'd originally thought. I suppose the romantic in me though 'we'll, I'll just sleep on the floor, because it's not going to take that long – things were happening so rapidly.' At a certain point I realized I had to get a bed. So, I came back to KC, came East for the meetings, and then went back to Kansas City.

**COOK Report:** Why Kansas City?

**Wilder:** My decision was made on a number of bases. Having roots here was a big factor, the cost of doing business here was a big factor, and wanting to provide a counterpoint to Google

Fiber was a big factor. It essentially came down to Detroit or Kansas City, and it looked as though there were already folks ([The Detroit Digital Justice Coalition](#)) doing excellent work in Detroit along the same lines in Kansas City.

**COOK Report:** Well, you could probably do it with less overhead cost in Kansas City. Was it since you were looking at the Google Fiber environment? In one sense, Google Fiber could be seen as the best of the modern build outs – in another sense, it represents quite a different model than your own.

**Wilder:** That was a part of the idea, certainly. The main thing is that folks are conscious of the issue here in Kansas City, in a way that they're not practically anywhere else. For the past six months or so, really the last three months in earnest, there has been a huge amount of conversation about network infrastructure here. So, here, at least, people are conscious of the fact that there *is* such a thing as a physical



network infrastructure. That's usually the first challenge. If we can start in a place where people already recognize that, it's a leg up, even if it means that we have to coexist with very advanced, privately owned, publicly subsidized networks.

**COOK Report:** So, Google Fiber is emblematic of the accepted way of doing things: big companies do it, and they own the infrastructure, and they own the customers? And you find yourself trying to present an alternative?

**Wilder:** Right.

## The Kansas City Experience

**COOK Report:** Okay, then. In the service of trying to make this accessible to folks outside of Kansas City, can you take the KC experience and recount what that has been like? Tell me about the people and places that are part of your work.

**Wilder:** I think it makes sense to contextualize it a bit within the bigger picture of what the oligopoly players are doing here, and who that effects, and where it is situated physically. We've discussed before how Troost Avenue is really a consummate historical and racial redline. To this day it is a major dividing line between races and economic classes, though there are also pockets of intense poverty in Kansas City, Kansas, and in the northland.

In these areas there is urban decay of the sort that you would find in other post-industrial cities. There's massive unemployment. It's a picture of disenfranchisement.

**COOK Report:** How does this relate to your efforts, and the efforts on the part of Google? I take it that the communities in those areas are underserved. Is Google making an effort to serve them?

**Wilder:** So, that's actually a big part of what I'm driving at. In order to understand the context here, it's important to understand what happened with Google Fiber. The deadline to pre-register for Google service was September 9th, 2012. Google got the City to agree to a build-out determined by demand: there were certain thresholds based on the cost of deployment, and those thresholds had to be met on a per-neighborhood basis in order for Google to come in. [Map below shows registration as on September 1.]

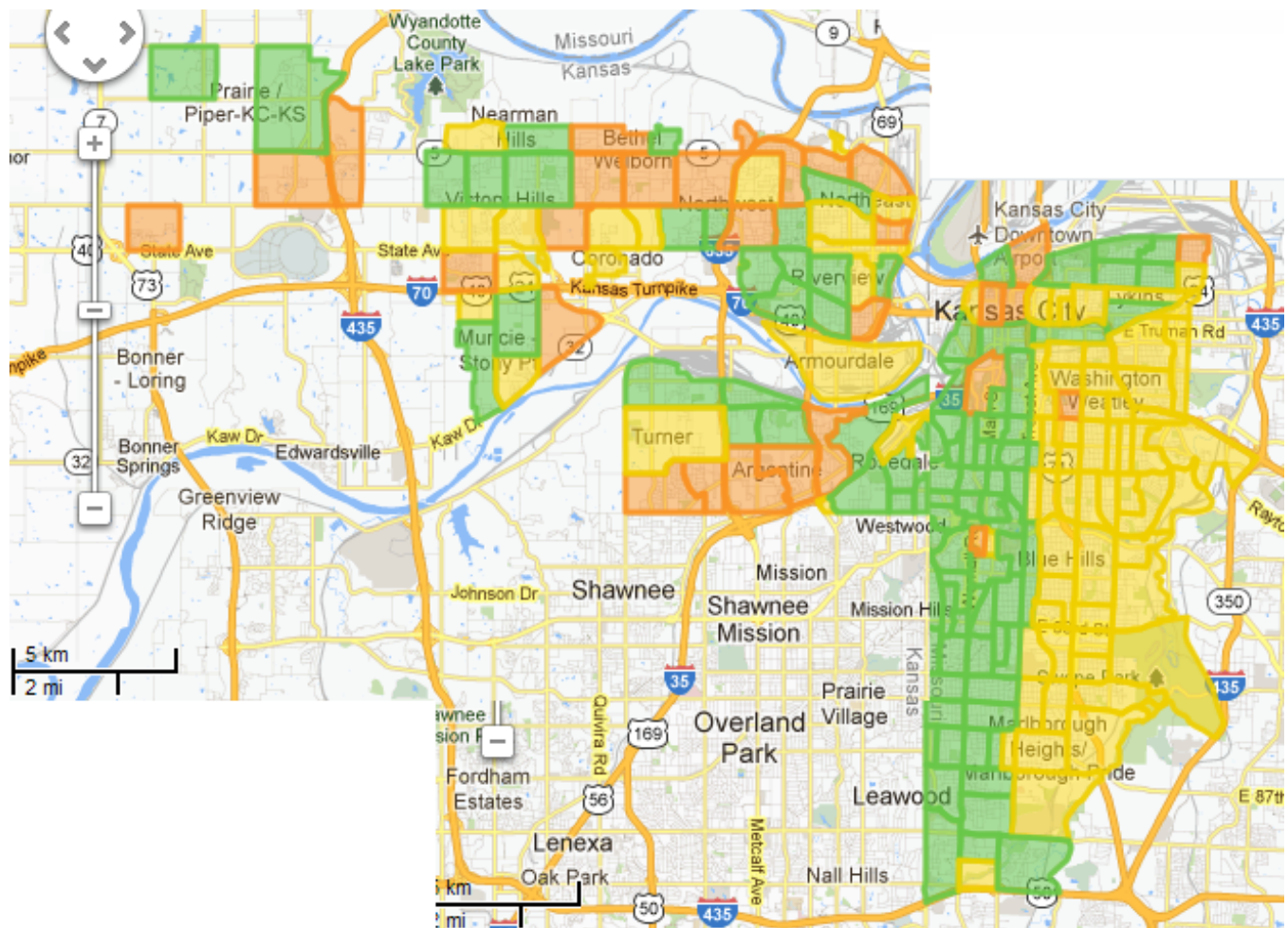



The policies that Google adopted wound up dividing the city exactly along Troost Avenue. If you looked at the map a week before the deadline, to the west of Troost was practically all green (served), and to the east of Troost was practically all red (unserved). Everybody saw that and knew that it looked really bad. In the last ten days of the drive, what happened, was that some folks actually went out in force and paid the registration fees for others, so that the map would not look as divided by race and class. It won't actually help those folks get connected, but it certainly helped with the optics of the situation. The problem remains that folks won't actually be able to pay.

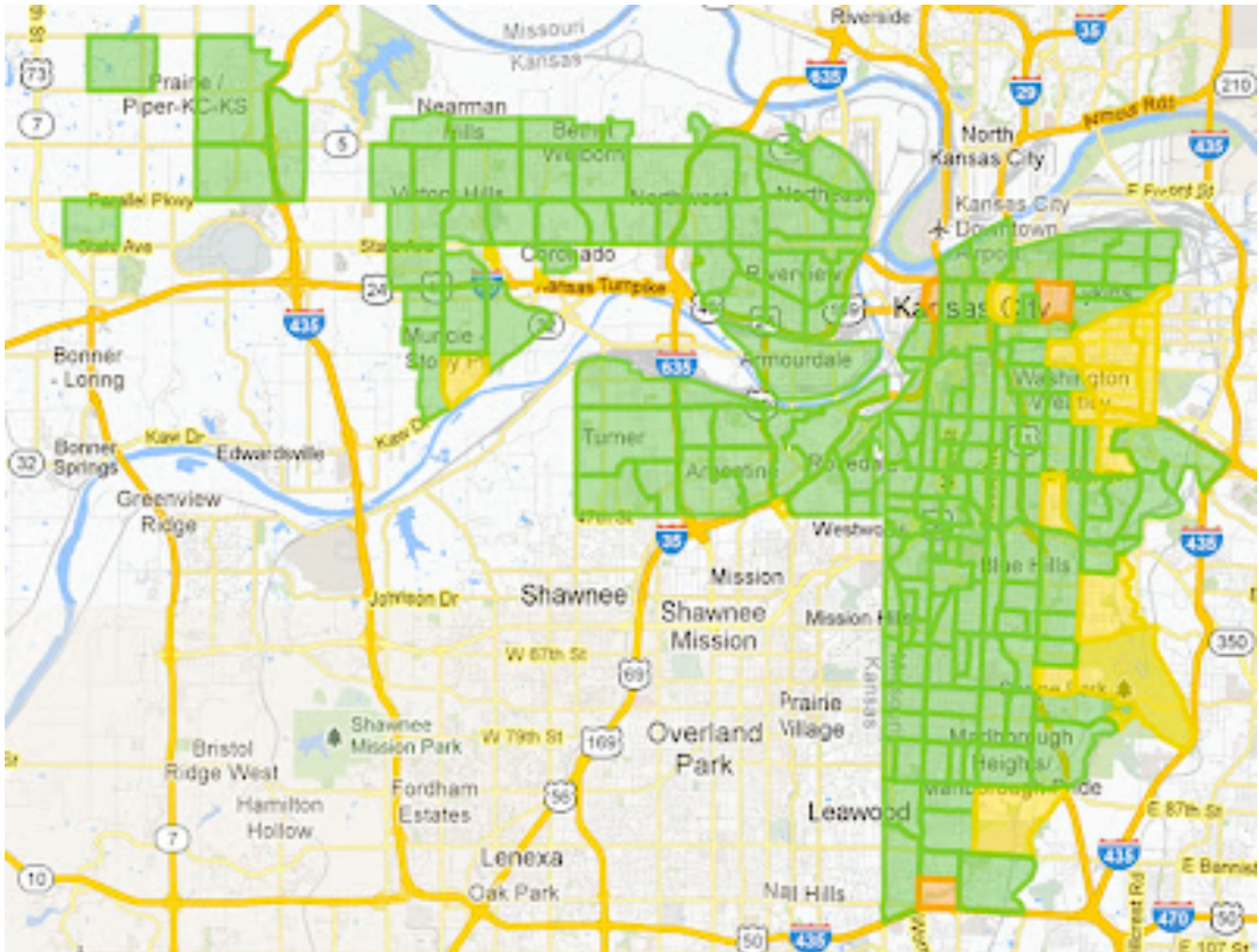

There was a non-profit named **Connecting for Good** [their building is shown at the top of the next page] that formed around the idea of getting Google Fiber brought into some housing projects, and then distributing connectivity via wireless mesh. Google basically told them to get lost. They said that doing it that way was against their terms of service, which, of course, is just a fancy way of saying 'no.' That's when we started to talk, and now we're working with Connecting for Good to provide the bandwidth that Google did not.



**COOK Report:** I know that originally the talk was of doing an open-access network. Do you know what happened to that idea? It seems that maybe Google switched its model when confronted with the reality of trying to bring open access not just to one market, but to many?

**Wilder:** I think that was certainly a part of it. The other notion that some people here appear to have is that the turning point in the development of the network business model occurred when Larry and Sergey brought in Milo Medin to actually realize what some people believe was Google's ambition to get into the access game. Keep in mind, though, that Google never actually came out and said that the network would be open access. In my opinion they certainly let people believe that, but they never actually said it. There were suggestions that shaped people's imaginations, and helped to get massive buy-in from all of these parties, but no explicit promises.

Some folks have postulated that the idea was to keep things vague so that cities would be willing to hand over GIS data by the hard-drive-full. That sort of data is incredibly valuable, and if you can get it by coaxing cities into competing with one another, it's certainly good for growing a network business. It seems possible that before they even got started, Google was able to come away with very detailed GIS and infrastructure data for more than a thousand municipalities.

**COOK Report:** Ouch! One thing that Google has been good at is laying the groundwork for future successes – particularly in the way of getting access to information. Some might put a moral judgment on that, but I suppose it comes down to what one thinks of "capitalism."

**Wilder:** Sure. Depending on what stripe of capitalism we're talking about. There's one way of looking at what Google has done as anti-competitive, which isn't really all that good for markets.

**COOK Report:** Well, it can't be proven one way or another, but it does make sense to realize that the stroke of genius would be to realize all of the GIS data that they could get. It does seem likely that they're using Kansas City as a template of how to approach other cities and do other build outs. To many of us, it became apparent about ten years ago that the telcos were not going to invest in the infrastructure. An argument could be made that, if we are going to have a modern-day telecommunications infrastructure, it looks like Google is about the only way to get there.

**Wilder:** If the only way to get there is via a route that entails total vertical integration of the information environment, it's almost certainly not worth it. We'd be sacrificing our natural and god-given rights for an industrial prowess that wouldn't actually serve to improve the human condition.

**COOK Report:** Sadly - that seems to be happening all over the place. What would an alternative path look like? What is going on in Kansas City as a response?

## But Why Are We Doing This?

**Wilder:** Let me try to use this conversation to explain. We had our first community meeting last Thursday, [**Editor:** mid October] at the Mutual Musician's Foundation, with the idea of initiating the somewhat sizable project of building a communications cooperative. Understand that such a coop would be independent of the FNF. The FNF is a research, development and facilitation group, but not an operating company in itself. So, last Thursday, about a dozen of us from different social change organizations in Kansas City got together to talk about forming a cooperative. Folks were there from labor, from Occupy, from arts and culture, and from small business.

## The Commons and Community Ownership: Understanding the "Free" in FreeNetwork

**Editor's comment:** This exchange show the difficulty of grasping the commons as infrastructure point of view for those just becoming involved.

**Richard:** But would you be able to reach beyond the coop?

**Isaac:** Sure you would. But you do have to pay. You've got to understand. The "free" here is not free as in free beer, it's free as in freedom.

**Richard:** Wait, what does that mean?

**Isaac:** So, what that means is that there's an economic and political element to what we're doing, which is, we're going to be autonomous and self-reliant, and in so doing reduce our cost in doing this, but also increase our ability to do it regardless of what anybody else says about our activities. And so, in that sense there are costs. And what I mentioned before about Oak Tower, what used to



be the Southwestern Bell Headquarters, and we've found a facility in there where-- there are three or four long distance providers so to speak, Internet long distance providers, that come into that building, it's one of the two main hubs in Kansas City. If we, as a coop, have a facility in that building, and then distribute that connectivity out into the city, we can have cut-rate bandwidth from that facility, plus the ability to communicate internally without even having to go out and through that pipe.

**Richard:** Well, I can understand this concept of "cut-rate" that you're talking about better than I can wrap my mind around this "free" thing you're talking about.

**Michael:** I think what he's talking about, basically, is the coop buys the bandwidth at wholesale. Just like, again, go back to the food coop, if we can buy it in bushels...

**Vickie:** The free part is like we have control. . . .

**COOK Report:** How does the work you're engaged in now relate to the early vision laid out in your writings when you and I first met?

**Wilder:** Well, the idea has evolved quite a bit in the last couple of years. Initially, our understanding was that there wouldn't be a need for any really significant backhaul into the network, because people would be able to utilize existing connections until a sufficient density of neighbor-to-neighbor connections could be achieved. We've actually found that it's necessary to seed the network with the type of low-cost connectivity that you can only be found in a neutral access point. So, while one would certainly hope that folks will connect devices to existing circuits for supplemental connectivity into their home, we're not in a position to advocate or bank on that, due to the legalities of most peoples' contracts with their current service providers.

**COOK Report:** I'd imagine that in the more depressed areas, it's likely that those existing circuits would be marginal, anyways.

**Wilder:** Precisely. So – the idea that we'll



“eat” the network from the inside out does still apply, but in a slightly different way than we had initially thought. Folks connect to the material, neighbor to neighbor network. They will need a source of backhaul, that they will provision cooperatively, in order to benefit from the economies of scale.

**COOK Report:** Isn't that similar to [Brough Turner's business plan](#)?

## What Is Different about the Free Network Architecture?

**Wilder:** I'm not sure that Brough sees the profound potential of the tech to shift the political economy of networks. He doesn't treat the network as a commons. And in any case, NetBlazr isn't at all concerned with the logical infrastructure necessary to tie it all together. Folks could join the free network from anywhere. That's what we mean when we say the plan is to eat the network from the inside out. Just connect a FreedomBox to any existing circuit, and it can grow from there.

**COOK Report:** Explain a bit about the tunneling. It would allow the free network in Kansas City to connect to the free network in Austin?

**Wilder:** Well, that's part of it. One element is that individual free networks would be connected to each other through persistent site-to-site tunnels from FreedomLink to FreedomLink. [**Editor:** the FreedomLink is the more powerful line of sight multi gigahertz connection from regional exchange points to local FreedomTowers.] The connection would run from tower to link and exit at the connected link to tower in another city. There is also another consideration: that anyone, anywhere in the world could tunnel to the nearest FreedomLink as an entry point into the network. They could tunnel in, get an address, and use that address for end-to-end encrypted communications.

In essence, somebody running a FreedomBox (or even just their own machine, if they're adventurous) could install a VPN client that would allow them to set up an encrypted connection with the FreedomLink. That way they can have a public IP address. The FreedomLink would announce their address out to the Internet, and so they'd be able use their IP address as it was intended – as a globally unique part of the routing space on the Internet. This would enable all kinds of neat applications that are either blocked or made difficult by Network Address Translation.

## The Co-operative: Legal and Physical Structures

**COOK Report:** So, you're going to start by building a cooperative – what does that entail in the next six months to a year?

**Wilder:** Over the next six months, what we'll do is partner with Connecting for Good in the Rosedale neighborhood, and try to get the kinks worked out in terms of technology and



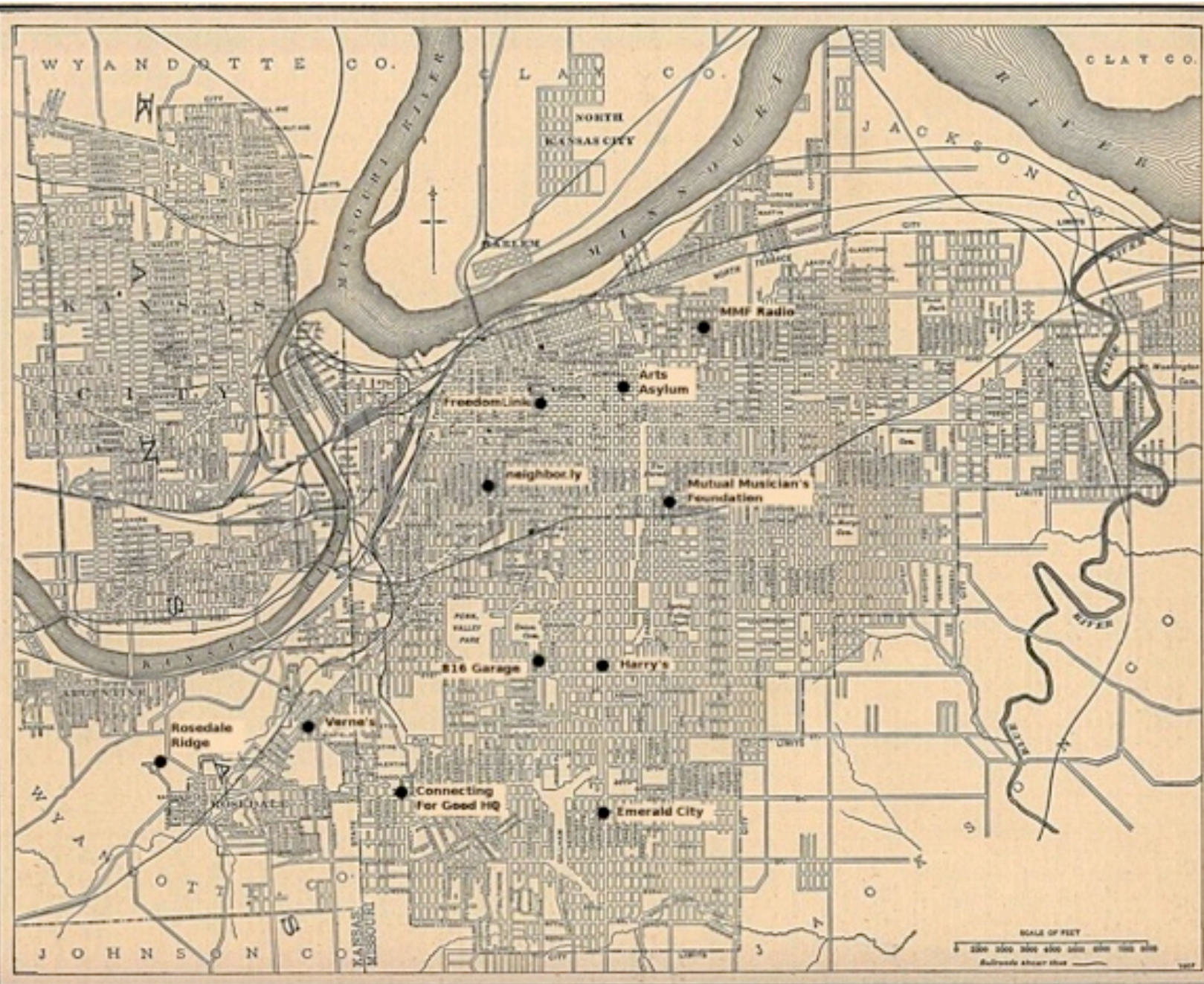

Note that the map above shows the physical location of the organizations involved in the services and infrastructure of the Kansas City freenet that Isaacs group is building.. Rosedale Ridge is bottom left and the FreedomLink at the Oak Tower exchange is top left Most of the organizations shown on this map are discussed in the text that follows.

deployment. We'll also figure out what the corporate structure for the coop should look like. In particular, our focus will be making sure that the network is owned and governed by its constituents. We're trying to come up with a set of bylaws that ensure mutual benefit and cooperation in perpetuity.

**COOK Report:** And this is a set of bylaws that the Rosedale network could adopt, or that a network elsewhere could eventually adopt?

**Wilder:** Yes. Exactly.



**COOK Report:** Give me a sense of the actual layout of the Rosedale network.

**Wilder:** Rosedale Ridge is 3.7 Miles from the [FreedomLink](#). They're up high enough, and the lines are right such that, if we can clear the trees, we should have a good shot back to the FreedomLink. What it will involve is likely a single point-to-point link at 3.65 GHz between the Freedomlink and the Rosedale [FreedomTower](#), with the potential for two bonded links if the throughput on one isn't sufficient. The FreedomTower would anchor a mesh network covering a housing development of 250 units, and potentially the neighborhood below.

**COOK Report:** So then, this doesn't depend on your finishing your suite of tools? What is the timeline?

**Wilder:** No. It doesn't depend on a finished stack. It's using existing hardware and software tools to do what hundreds of internet service providers have done, but doing it with an eye towards empowering people. We want to help people who need access to serve themselves.



**COOK Report:** And what is the role of [Connecting for Good](#) in all this?

**Wilder:** They'll be running education programs, as well as collecting and distributing computer hardware at low cost. We're sharing responsibility for the network in the short term as we figure out the best way to put it under

its participant's control.

**COOK Report** How then, are you reaching out to the communities that will participate?

**Wilder:** Well, a lot of the outreach for the Rosedale piece has been done by Connecting for Good. We've focused our efforts more on the east side. One of our biggest allies has been the [Mutual Musician's Foundation](#), which was formed in the thirties as a protective union for black jazz

musicians. Through our friends there we've connected with a number of other groups, and have started hosting community meetings. Our approach is just: hey, let's work together to solve this problem, and people seem very open to the idea. They're skeptical of the providers like Google Fiber and AT&T- they know that the point of those outfits is to make money off of them. Any service costs money. Nothing is truly free. But we believe that our service can be delivered for a lot less and help to keep the money needed in the local economy.

**COOK Report:** So, it's you and who else on the ground?

**Wilder:** Well, my colleague Tyrone relocated to Kansas City. He's a friend from my college days, and was indispensable to our actions in New York City during the Occupy Wall street action. He has a background in history and helps a great deal with administration. We've had a number of local contributors on the technical side come on board, but on the organizing side it's mostly me and Tyrone, and the folks from Connecting for Good.



**The Rosedale Ridge Apartment complex**

**COOK Report:** So, I guess you need a few more months working with groups to figure out where your first towers will go?

**Wilder:** Well, there are a limited number of places that make good sense, given the geography of Kansas City. So, we're approaching those folks that have high ground to see if they'd like to put something up. To give you an example, we've been working with some folks from Occupy Kansas City to repair the roof on an old building at 31st and Troost, which is just about the highest point in the city. Hopefully in exchange for that, we'll get some space there, and be able to put some radios on the roof.

**COOK Report:** So you'd put a FreedomTower there?

**Wilder:** Yes. Exactly. And from there it would be hop-by-hop. We've been working with an artist collective and housing initiative called Emerald City that's a bit further to the south, in an area of town called Manheim. They're putting up a radio mast, and we ought to be able to put some radios on there.

### Wireless mesh network and freedomTower antenna and gear at Rosedale Ridge

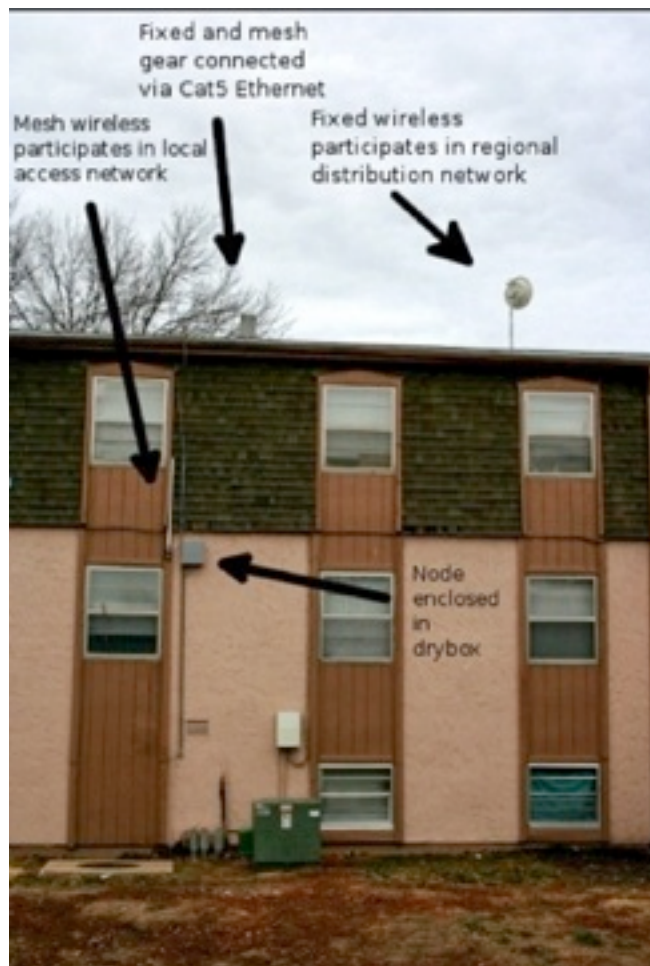



**COOK Report:** So are there different classes of FreedomTowers – one variety for key locations, and one for less critical ones? And one about nodes and boxes? How do they fit in and what is the different between them?

**Wilder:** As far as the tower question, you're right that there would likely be different variety with more or less power or different types of antennas, depending on the situation. ***The important thing to take away is that the FreedomTower serves as a bridge between the regional point-to-point backbone network and the neighborhood mobile ad-hoc network.*** By definition, FreedomTowers participate in the point to point network – whether they communicate with the FreedomLink directly, or with another, intermediary FreedomTower isn't hugely important. What is key is that on the one hand they are communicating with other regional network devices, and on the other hand they are **also** communicating with the nodes of the neighborhood network.

**COOK Report:** Okay, and what is the difference between the node and the box?

**Wilder:** Right. The node is a radio device. It would behave like a modem. So, [FreedomNodes](#) are radio components, and their role is to build the material network. The [FreedomBox](#) is a small form server running a suite of logical tools that allow people to communicate with end-to-end encryption, and to take advantage of the local connectivity provided by the nodes.

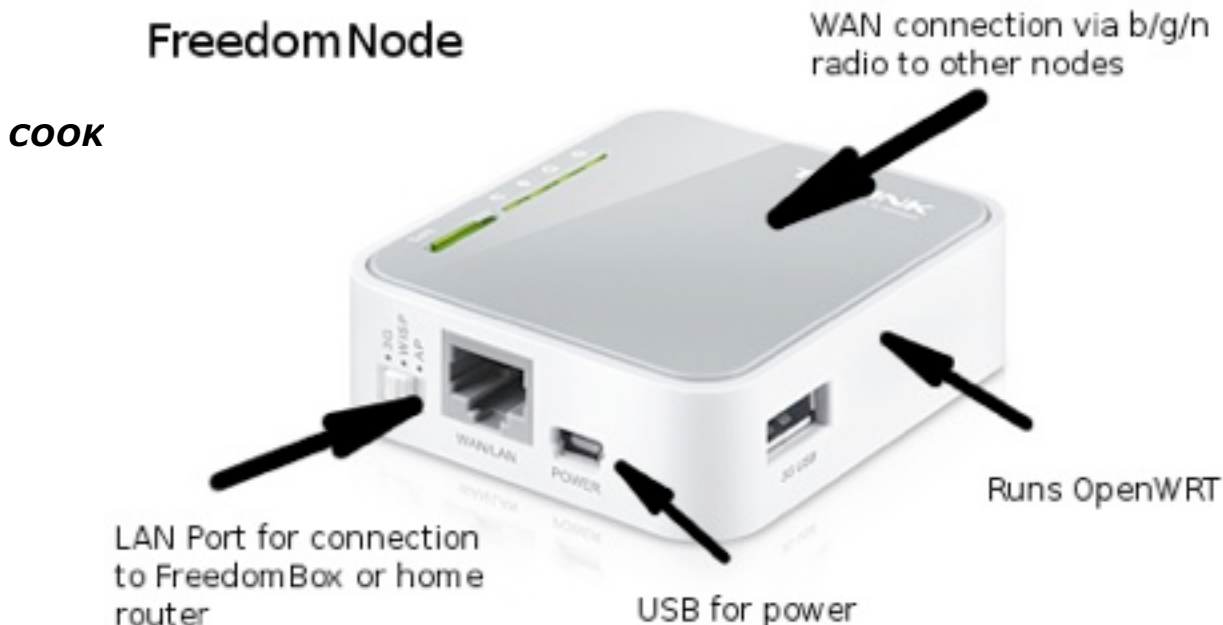

**Report:** I get the sense that the FreedomBox would be an add-on to an existing computer – is that right?

**Wilder:** Not exactly. You're right that you could use whatever computer you like as your own machine. The FreedomBox, plain and simple, is a server – a low power server. It doesn't necessarily have a radio. It doesn't have to participate in a mesh network. You would access it by opening up your laptop and typing 'myfreedombox' into an address bar, and an interface would come up that provides access to the services running on that device.

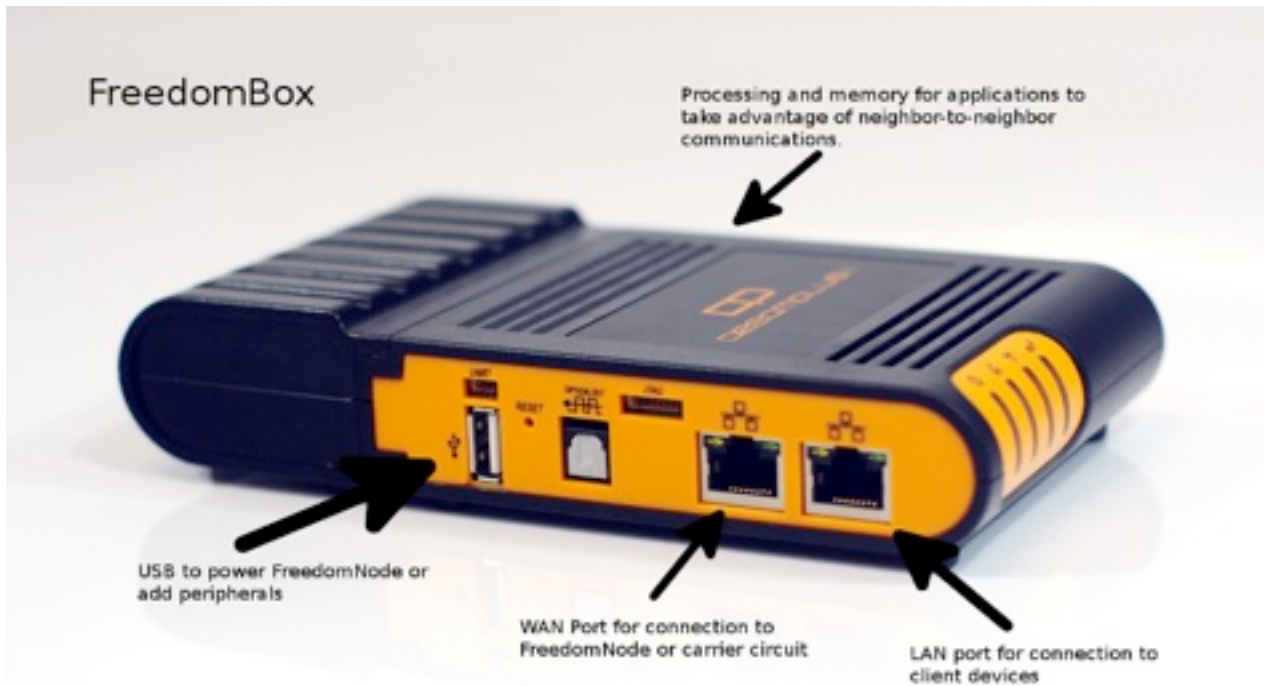

It would either be connected to your router, or replace your router. So, in the simplest full setup, you'd have a FreedomNode acting as a modem, and a FreedomBox as your router – you'd have connectivity via the node, and you could access the services running on the FreedomBox via a web interface.

**COOK Report:** So the freedomBox would replace your old Linksys router? But it would have additional software capability?

**Wilder:** Right.

**COOK Report:** I see. So will there be a device that combines the function of the FreedomNode and the FreedomBox?

**Wilder::** There certainly could be. I think it makes sense to have them available in a modular way for two reasons: it allows anybody to plug a FreedomBox into an existing circuit and participate in the logical aspects of the free network, and on the other hand,

you could have just a FreedomNode, and have the same sort of Internet connection that's provided by an ISP, except cheaper. Ideally, folks would do both. The functions are distinct: the FreedomNode is concerned with things up to layer 4, and the FreedomBox is concerned with things above that.

**COOK Report:** So not everybody would necessarily need a box?

**Wilder:** Exactly. But the reason why the box is important is that it would allow for the proliferation of the network to physically disparate places, that can then grow together because they have a unifying logical layer. Far-flung boxes would have to tunnel in to get a public IP address, while nodes would hand them out directly, but either way end nodes would have their own address for communications. I should say though, that we're not as focused on the FreedomBox as the node, the tower and the link. [FreedomBox](#) has its own foundation that is driving that project. We're staying focused on the connectivity issue.

**COOK Report:** And you're watching them to make sure that you can plug their product into your connectivity mesh easily?

**Wilder:** That's exactly right.

**COOK Report:** Can you say what remains for them to do before they've got a usable product?

**Wilder:** They need to take a web interface that exists, and make it so that instead of being a mock up, it actually hooks into the system in a meaningful way. Teaching the interface and underlying software to "push" all of the right buttons in Debian is not a small task. There's a lot of logic that has to go in, in order to do it right: system administration is hard, and we're basically talking about building a server that both administers itself, and self-healing.

**COOK Report:** As an architectural design and development task, is this something that you're working on spreading out?

**Wilder:** We're trying to distribute the workload, but it has proven hard to find people that are willing to give their time and energy to a project that seems so big in its scope. It's like we're asking people to participate in a project to build a moon colony. They say it's out of reach. We do have people in a number of places, but we need the right infrastructure to collaborate effectively. That's actually what we've been working on more than anything else, by far: the infrastructure for that distributed workflow. *Companies can take that sort of stuff for granted, because they have large budgets with which to provision it, but for a free software project, it's much more difficult to take on a project of this scope.*



**COOK Report:** It sounds like you're saying that you don't really have a sufficient off-the-shelf tool kit for distributed development? [**Editor's note:** Isaac suggested around the first of December this very big network in Spain called guifi.net as readers have seen by now I did and my world will never be the same. As proof of concept of the feasibility of what Isaac is doing guifi.net astounds!]

**Wilder:** That's right. Not at the scale we're attempting. The other thing to understand is that what virtually any other project would do is use infrastructure provided by a number of big enterprises. Instead of just signing up for accounts with Google and [Github](#), we've decided to take matters into our own hands, and to maintain our own tools.

**COOK Report:** So, on the one hand you're developing the suite of appliances for building replicable, horizontal networks, and only the other hand you've developing a rack of tools that are Internet accessible to developers, so that they could log in and use them to work on improving the appliances?

## The FreedomCenter

**Wilder:** That's right. That suite of tools we've branded FreedomCenter. The idea is to offer resources, space, and tools for likeminded projects. We're trying to lay the foundation for what we hope will be a global community.

As with much of our work, the technology is not unprecedented. It is the intended use of the technology, rather than the technology itself that is far more central to understanding our mission. In addition to supporting all of the FNF's back office and web applications, FreedomCenter will provide for continuous compilation and rolling release of software and firmware, a self-service virtualized network testbed, and a multi-tenant runtime and radio lab.

**COOK Report:** Tell me what the various components do.

**Wilder:** Sure.

**Stor01 and Stor02**, the systems at the top of the rack, represent our storage cluster. Each systems runs [FreeNAS](#), which is a storage appliance operating system that leverages [Zetabyte File System](#). This system enables storage snapshots, automatic deduplication of data, replication of datasets, and presents all volumes to the network as NFS shares.

Our Production environment (internal and external web applications) live on Stor01 and are replicated to Stor02. Our Development environment lives on Stor02 and is replicated to Stor01. This provides for maximum IO, reduces disk contention, and ensures a near-line backup of all mission-critical data.

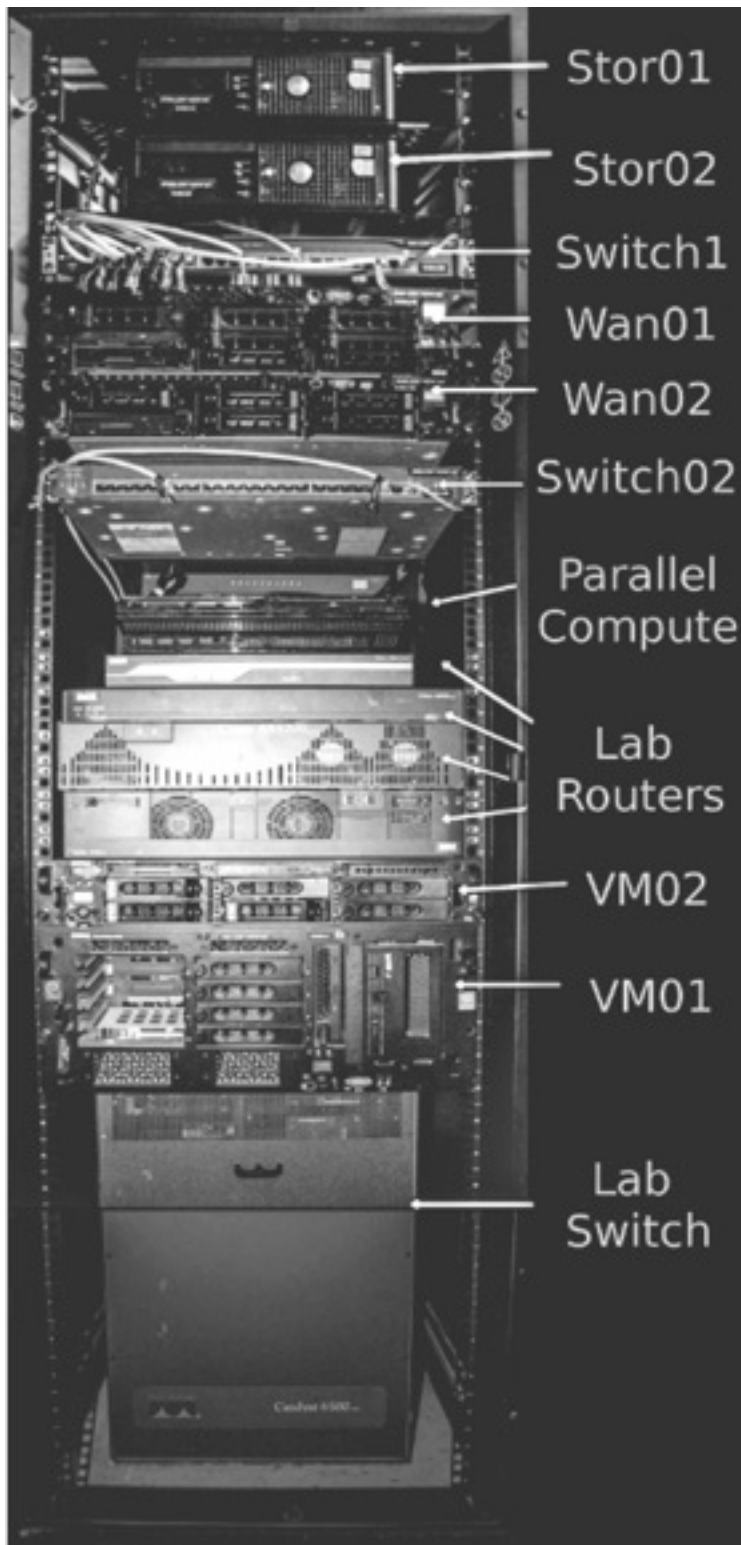

**Switch01 and Switch02** are Fast Ethernet switches. In the configuration shown in the image, Switch01 is in operation, and Switch02 is a warm standby. We are presently implementing a configuration in which the switches form a redundant fabric, leveraging Per-VLAN [Spanning Tree Protocol](#). These switches provide for (V)LAN connectivity for all of the other devices pictured.

**Wan01 and Wan02** are our edge routers, connected to our upstream providers on one side, and to the LAN on the other. They are responsible for Firewalling, Routing, serving DHCP to the LANs, and acting as VPN concentrators for remote access. They are connect directly to each other in a High Availability configuration, so that if the primary fails, the secondary takes over automatically.

**[The Parallel Compute box](#)** is in fact a PlayStation 3, whose cell processor provides extremely well parallelized computation power. This is particularly useful in the batch signal processing workload of Software Defined Radio, and for running large scale simulation that leverage parallelized algorithms.

The **Lab Routers** are various pieces of common Cisco routing and firewalling gear, intended for use in a remote-access network sandbox. The

idea is that folks can schedule a time to use the lab to get hands on experience with various elements of core networking. This would be extremely useful to folks that are looking to earn network certifications, or generally increase their network chops.

**VM01 and VM02** are our virtualization servers - at any given time, there are several

dozen virtual servers running on these boxes. The boxes run Ubuntu 12.04 on the bare metal, and use Linux Containers for virtualization. Container workload is load balanced across the machines, but in general, core infrastructure (DNS, MySQL Server, Mail, LAMP and Ruby applications) run on VM02 and Development infrastructure runs on VM01.

**The Lab Switch** is a [Cisco 6509](#), which is, similar to the Lab Routers, intended for use in experimentation and learning. Our goal is to offer these resources to the public in an effort to democratize networking knowledge, and get more people to a point where they are able to build and contribute to community network commons.

## Envisioning Emergence

### Phase 1

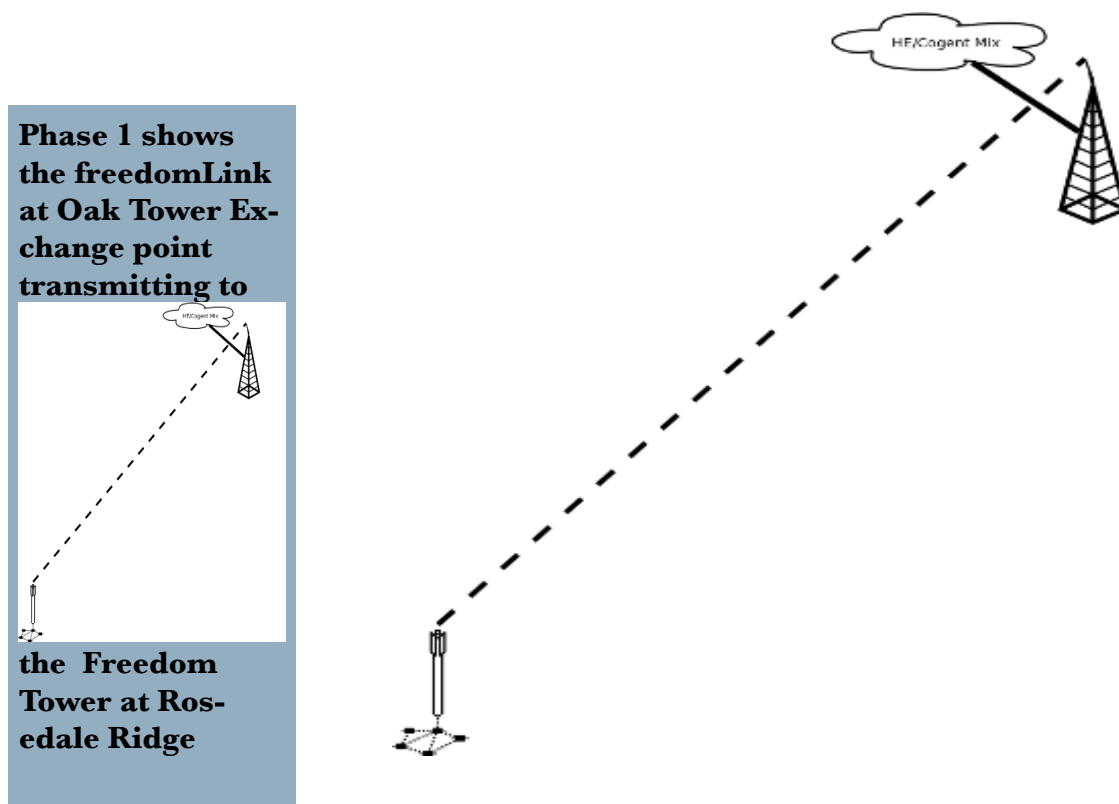

What follows is not a prescriptive visioning. It is an exploration of how some portions of a global free network might emerge. It is not intended to explain the design of the relevant tools and technologies – but rather to augment one's understanding of what these tools are designed to *do*. **This particular depiction is a to-scale depiction of our projected growth curve in Kansas City.**

The network emerges as a modest internet co-op – it is not particularly groundbreaking in its technological functioning, though there is a healthy amount of systems engineering and integration that goes into its construction. The FreedomLink is situated in a building with major network POPs, such that it can take advantage of wholesale bandwidth at



competitive prices. A housing complex, small business, or community center hosts a FreedomTower with a Line-of-Site microwave link to the Link. A few well-placed FreedomNodes help distribute connectivity to the surrounding complex. Publicly routable IPv6 addresses are delegated from the Link to the Tower to the Nodes to client devices. Because the network does an end-run around for-profit middle mile and last mile networks, it is able to offer high-speed connectivity to its participants at a small fraction of the retail cost.

In this particular case, the FreedomLink is in [Oak Tower](#), downtown, and the first FreedomTower is at Rosedale Ridge, in Kansas City, Kansas. This phase of emergence was completed in December 2012.

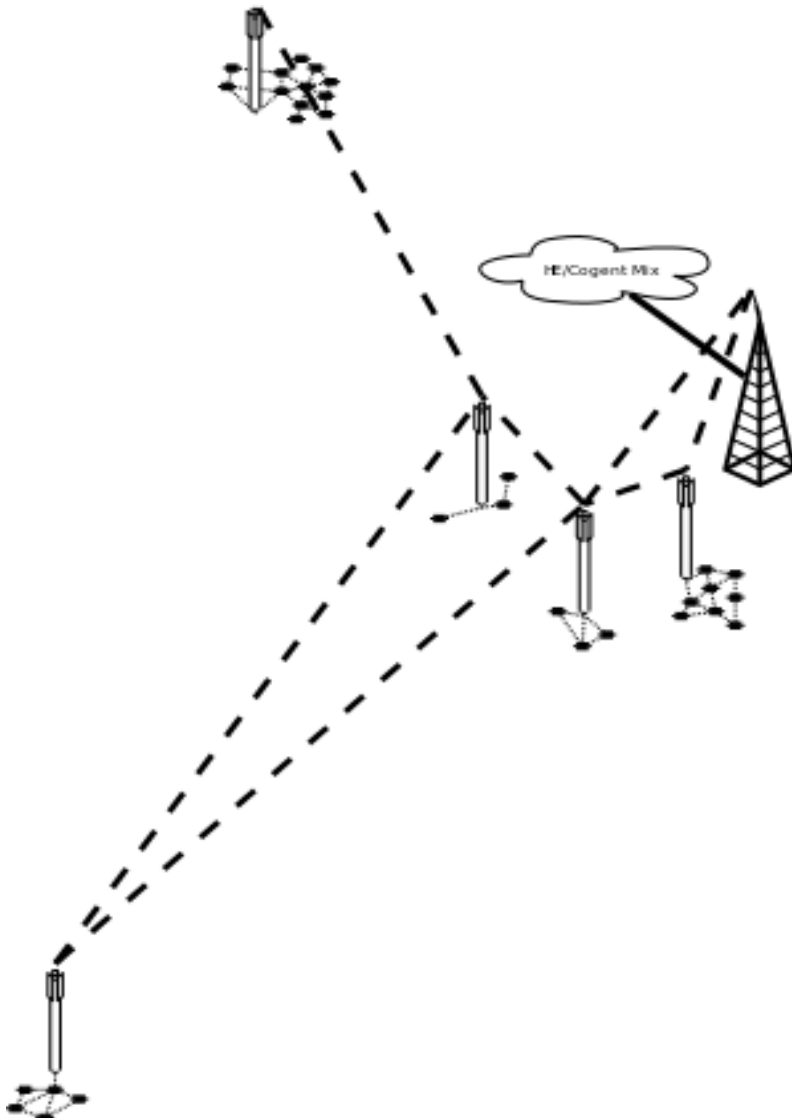

## Phase 2

The scale of a neighborhood access network is limited by geographic proximity and routing overhead. Additional anchor institutions are compelled to join the regional distribution network because it affords an opportunity to save on connectivity costs while providing a service for their community. As additional FreedomTowers come online, the process increases the robustness of the distribution network.

The commons-based model of free networking dictates that there is no single economic formula for provisioning infrastructure. Instead, each site is free to choose their own model. Where some neighborhood networks might be provisioned by non-profits

or public sector actors, others may be funded through a neighborhood association, a civic campaign, or private capital.

As density increases, and the number of locations willing to colocate a tower increases, better lines of sight and more robust network topologies becomes possible. Longer links

are replaced with shorter ones, increasing capacity. Private interests can participate in the network, the only stipulation being that they cannot treat their network segments as their private property. Any participant is free to reclaim any equipment at any time, but as long as the equipment is participating in the free network, it must be open to all on equal terms.

In real terms, we expect of the next three months to see the [Westside Project](#) and [Juniper Gardens](#) come online, funded by a non-profit in conjunction with the KCK housing authority, the headquarters of the FNF, funded by a private corporation, and the Crossroads mesh, anchored by [neighbor.ly](#), and funded through a mix of crowdfunding and neighborhood association dues.

The network continues to grow, as neighbors and neighborhoods cooperate to achieve mutual benefit. Individuals are able to buy nodes ready-made and have them installed for a modest fee.

### Phase 3

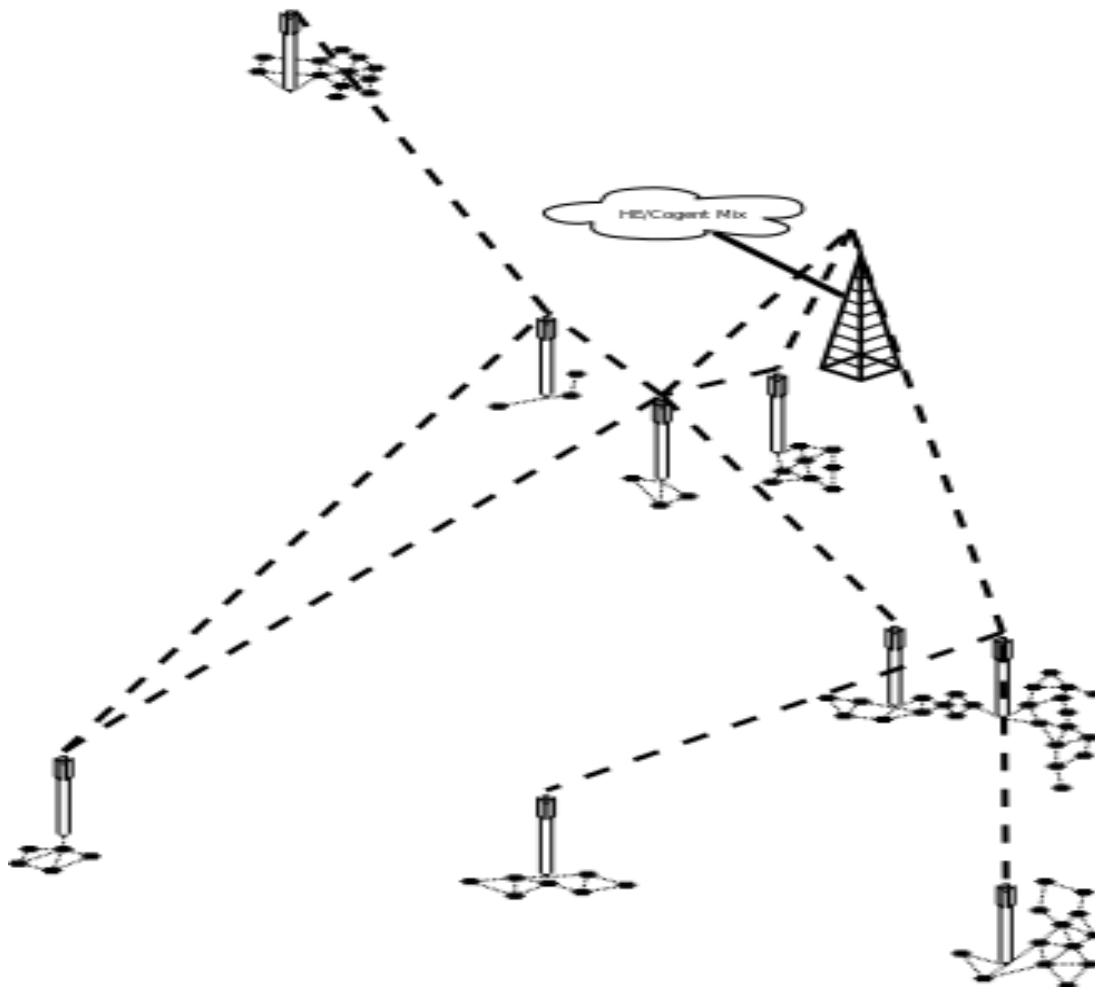

***Because the network is open for all to use, those with a marginal connection or just outside the range of an access network have an incentive to help grow the network into their geographic proximity. The network landing page can be configured to display the sponsors of the various pieces of infrastructure currently in use by a participant, providing an opportunity to strengthen the civic spirit of blocks and neighborhoods.***

A single neighborhood network can have multiple towers, as shown at right. This provides another layer of robustness to the architecture. In this case, Harry's and the 816 Garage are close enough that it makes sense to have a single access network between the two. Because they both offer excellent (and different) lines of site, it makes sense to have multiple towers so nearby.

We expect the four new towers in this phase to be built over the next six months. The 816 Garage and Harry's towers will be funded through the collective effort of voluntary associations ([The 816 Collective](#) and Industrial Workers of the World, respectively), the Emerald City tower will be funded through a neighborhood fund-raising project, and the Connecting for Good tower will be funded by a non-profit with corporate sponsors.

## Phase 4

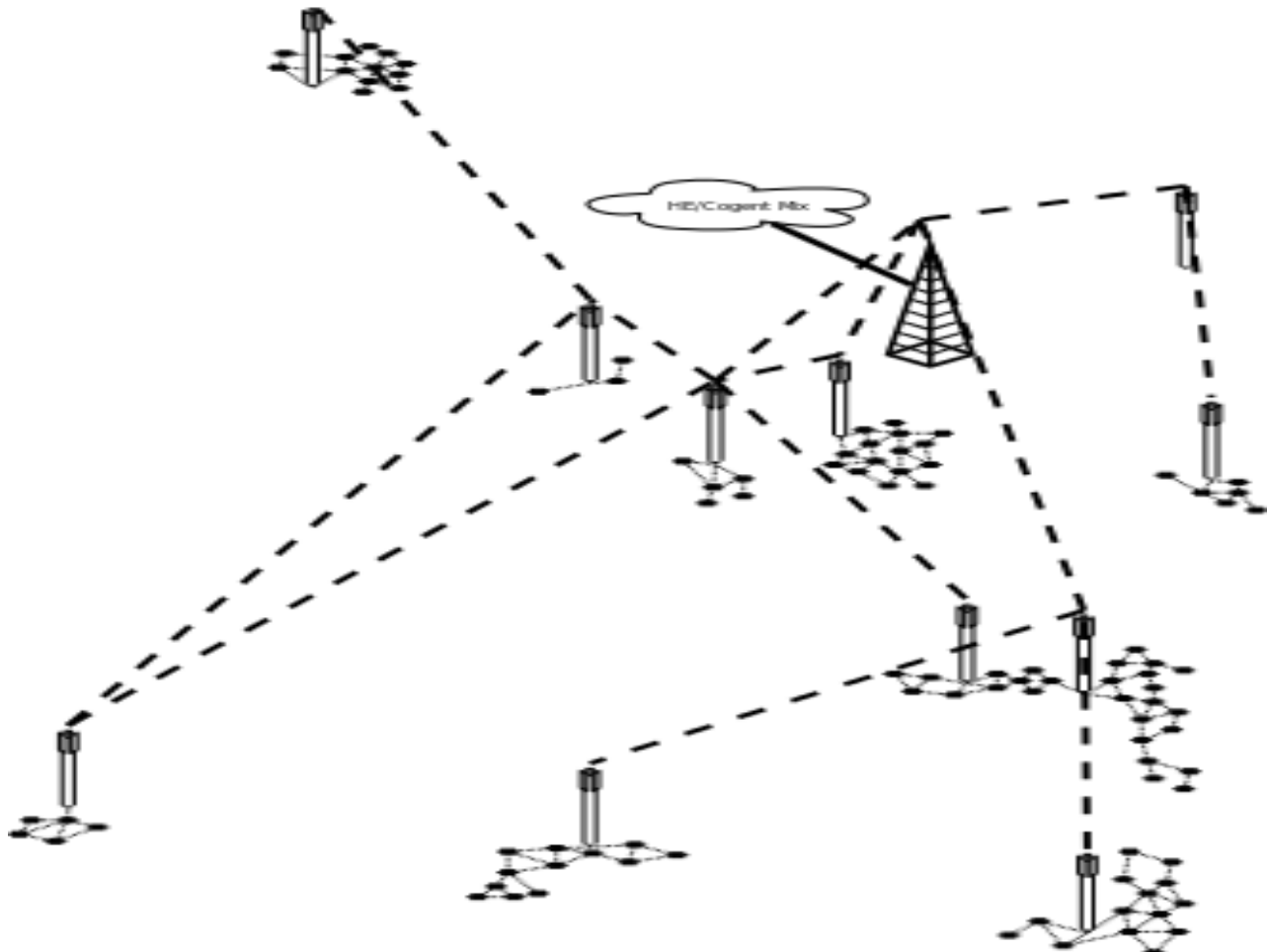



For the sake of simplicity and intelligibility, I have only depicted here the emergence of a single material subsystem – ignoring the parallel development of other regional cooperatives, or the logical infrastructure to tie them together. The intent is to give the reader some idea of how such a system could come about in practice.

Our contention is that increasingly large and more numerous material subsystems will grow inside of the Internet. Free networks will begin to eat the network from the inside out. Carriers will either compete for the business of backhauling neighborhood access networks, or be cut out of the picture by a material end-run.

FreedomLinks will provide the logical infrastructure for federating regional networks – this means global routability for end nodes, and a high degree of identifier portability. They will also act as VPN concentrators, allowing anyone with any type of connectivity to participate in the network on a logical basis, until such time as they are able to do so on a material basis. Sites that tunnel into the overall logical network can anchor a material network of their own, that will eventually grow to meet, and fuse with, a larger network.

***As regional cooperatives grow, they economies of scale will only continue to improve the value of the growing commons. Just as neighbors and neighborhoods are able to organize infrastructure provisioning for mutual benefit, regions will be eventually able to buy or build their own transit capacity. Everything interconnected under the understanding that we all give, and we all receive in turn – a communications commons, built by all, maintained by all, and for the good of all.***

## Making Headway

**COOK Report:** Now that we have gone from the conversations of late October, what are the highlights in November and December and so far in January? Technical, social, political, economic, how would you characterize some of the events?

**Wilder:** Sure. So I think the most significant thing to have happened is that the Rosedale Ridge project, which was in a planning stage when we last spoke is now live. It's providing connectivity to about 200 families, only one of which, I believe, had connectivity in their home before the network was built. So it's quite a difference in the lives of these couple hundred families.

**COOK Report:** How was it was executed?

**Wilder:** Well, we were able to negotiate a deal for backhaul at Oak Tower, and basically build the first production FreedomLink, build one FreedomTower at Rosedale Ridge, with a point-to-point microwave link between the link and the tower that delivers roughly forty megabits of bandwidth to the site, where it is distributed via a mesh network.

**COOK Report:** So what was the cost of getting this done? How did the economics work out?

**Wilder:** Sure. To colocate the FreedomLink consisting of a core router and radio dish, and pay for the backhaul we negotiated a rate of \$125/month, which compares quite favorably with the \$350/month that Time Warner Cable wanted for a similar amount of bandwidth. It would have been more, but we were able to work out a deal to locate our radios inside the data center, rather than on the roof, saving a couple hundreds dollars per month. There's a slight performance hit, a few dB, but it works! The cost for the point-to-point gear was a little less than \$500, and then the mesh gear was donated, but had it been bought retail, it probably would have come in around \$400.

**COOK Report:** How many nodes are there in the mesh network?

**Wilder:** There are four repeaters in the complex, and we're thinking about installing four more to increase the coverage. Everybody has at least a marginal link right now, but there are some people on the periphery that don't have a very reliable link to the network.

**COOK Report:** So each repeater costs about \$100?

**Wilder:** Maybe slightly north of there. Do understand that because the gear was donated, it's not what we would ordinarily want to use. It's proprietary gear from Meraki, and it is actually program to become useless in about two year from now. So at that point we'll want to go in and replace the repeaters with ones that don't limit us as much.

**COOK Report:** Lord! I'd heard about Meraki, but I never heard that.

**Wilder:** Yeah. It's pretty crazy when you think about it. In any case, though, it's sort of a temporary solution to get us off the ground, not to mention that there seems to be some merit in the idea of repurposing or reusing technology that would otherwise end up in a landfill. So, those nodes cost maybe \$100, \$125 a piece. The new Meraki outdoor gear is more expensive, it costs about \$1000 per unit, though the units are more powerful. Of course, you could homebrew something even more effective for around \$500. That's something that the FabFi group has done a marvelous job of making more feasible.

**COOK Report:** And not self-destructing, right?

**Wilder:** That's right.

**COOK Report:** Okay, what has the reaction been from the users?

**Wilder:** It has been incredibly positive. The Kansas City, Kansas school district sends home laptops with all of their high school kids every day, and I think thirty or forty of

those have logged on. All in all, several hundred devices have logged on – Android devices, to a large extent. In general, the population there at Rosedale has been really, really enthralled with the network. Because Rosedale Ridge is up on top of a big hill, and there's poor bus service, it has always had trouble leasing out their apartments. Since the installation of the network, they have leased every apartment in the complex.

**COOK Report:** Well, that makes good sense. I am sure that the complex developer is very pleased. What interaction have you had with them?



**Wilder:** We needed their permission to go up and do the install, and they have actually agreed to pick up the bandwidth costs going forward.

**COOK Report:** Good. Now let's turn to education. The school district distributes laptops, but many of the kids take them home and can't get on the internet? Is that common?

**Wilder:** In economically depressed areas, it's very very common for one, maybe two families in a square block, or in a big housing complex to have connectivity. In fact, just last week,

**Rewards of a job well done -- Isaac stands by the FreedomLink dish antenna in the Oak Tower building that formerly was the headquarters for South Western Bell in Kansas City (one of the seven baby Bells). The Freedomlink is Etherneted to a router and the global Internet a few feet behind where Isaac stands. The signal connects to the FreedomTower at Rosedale Ridge**



**there was an incident where some cops were driving by a school and they saw a crowd of kids, and so they called the principle, saying "Hey, I think something is going on, you'd better get down here." When the principle got there, it turns out the that the kids were sitting out in the cold so that they could pick up the wifi and do their homework.**



On December 22, 2012, after two days of training, Dan presents a free refurbished laptop to one of our five Ambassadors at Rosedale Ridge. They will use them to demonstrate to other residents what can be done online and encourage many more to attend the digital life skills sessions.

**COOK Report:** Besides the students, do folks have computers? Do they have the skills to actually use the network?

**Wilder:** For those that don't, we have partnered with a couple of local non-profits, [Connecting for Good](#) and the [Urban Youth Center](#), who are running a digital literacy program, and selling subsidized, very low cost laptops. We've done a pilot of the education program with the first group of five residents, who we call 'ambassadors' – they're charged with helping others get on and taking advantage of the network.

There was much media coverage of the Rosedale Ridge connection. The story from the *Kansas City Star* is [here](#).

**COOK Report:** So, I know that the Rosedale project was covered in the local media. Has anything come of that coverage?

**Wilder:** Definitely. There has been a huge surge of interest. Right now we're talking with two more housing complexes that are interested in working with us, and with some folks

in the Crossroads neighborhood. There's really been a surge of interest in DIY connectivity – where before people didn't even realize this was possible, now they can see it, and very many of them are interested getting involved.

**COOK Report:** Sounds like it has a pretty good impact.

**Wilder:** Yes. Definitely. It's allowed us to strengthen our cooperation with Connecting for Good. I now sit on their Board of Directors, and they've agreed to act as our fiscal sponsor until such time as the IRS responds to our application for tax-exempt status. So there's all that, we're planning more cooperation with them, and are very pleased to see a free network growing in Kansas City, but there's actually been a lot more than that going on.

**COOK Report:** Do tell.



**Photo Description**

**Needed!!!!!!!!**

**Wilder:** Work has continued on FreedomCenter in a really productive way. Something that I imagine you'll be pleased to hear about is that we've taken a piece of software developed by Guifi and a couple of the other European Community Networks, called [CONFINE](#), and are using it to automate a lot of lab functions that would have been a real pain.

**COOK Report:** So, what exactly does it do, and how are you using it?

**Wilder:** Basically, it's a piece of software that can manage a radio testbed in a very flexible way. So, we've stood up an instance of that software, and I'm actually going back and forth with some folks from Guifi now about potentially even federating those instances across a VPN. A couple of the European sites that have instances are interconnected that way, and we might actually join up with them and for a sort of global testbed.

**COOK Report:** That would be really neat. At any rate the Guifi software allows you to set up a network testbest in some virtualized form?

**Wilder:** That's exactly right. It allows you to manage a bunch of radios in such a way that you can try novel things with them, and have different firmwares virtualized simultaneously so that you can get feedback on the performance of different configurations.

**COOK Report:** Interesting. Suppose you wanted to test the performance of some new radios at some new points of interconnection with where you are in Kansas City. I would be surprised if this could actually test the feasibility of particular placements in such a situation.

**Wilder:** Right. It doesn't allow you test for link quality. It doesn't replace a site survey or an RF survey.

**COOK Report:** Can you plug GIS data in, and say "supposing I put a radio here, where would I have to put another radio to establish a link" - can you do that?

**Wilder:** That is definitely a part of FreedomCenter, and it's a capacity that Guifinet has built out in a very robust way, but it's not a part of this particular software. CONFINE has a very specific research and development focus, where what you're talking about, as you said, is more along the lines of GIS software.

**COOK Report:** So, what about the other places on the map? What about Neighbor.ly?





**Wilder:** Sure. Neighbor.ly is a civic crowdfunding organization that we've been working with in order to do a much larger scale, neighborhood-wide FreedomStack deployment there, perhaps in the next couple of months. It would be a fairly large starter network that folks could expand on their own terms. We are thinking of raising perhaps \$20,000 to \$25,000 from the surrounding community, and that would provide enough capital to plan the seed of a wider free network. The initial footprint would probably be about 8x8 [square blocks in the Crossroads.](#)

**COOK Report:**

And what about Harry's what is that?

**Wilder:** That's a building owned by a supporter named Harry, at [the corner of 31st and Troost.](#) Along with some folks from Occupy and my union local, we've been fixing it up, starting with the



leaky roof. Up until the 80's, I believe it was a mall of sorts: with a nightclub, a restaurant, a hat shop, and some other merchants. Now there's nothing in it. Once we've restored it to better shape, it'll be the '[Osage Trail Entrepreneurial Development Center](#)', with classroom and office space, and so on.. It stands at a very central, very high point, and has perfect line-of-site to Oak Tower, so we're planning to use it as one of our central FreedomTower sites.

**COOK Report:** MMF Radio?

**Wilder:** The Mutual Musician's Foundation recently got a permit to launch a low-power FM station, so they're putting up a mast, and they've agreed to let us put some microwave gear on there. It'll be a perfect distribution point into the 18th and Vine district.

**COOK Report:** [The 816 Garage?](#) (Shown below).



**Wilder:** That's a bike collective. They're a sort of voluntary association that works on old bikes and sells them for cheap or gives them away. They've got a building at 31st and Cherry that they're renovating, and they're very eager to put a FreedomTower there, which would help us cover the Union Hill neighborhood.

**COOK Report:** Westside?

**Wilder:** Westside is a senior center near 17th and Summit, on top of the bluff that stands between Kansas City, Mo and Kansas City, Kansas. It's the tallest building in the area, and would make for a great central relay for the west side, where Harry's building is on the east.

**COOK Report:** I see. So let's change gears here a little bit. I am curious how things are progressing with Google Fiber. Do you know anybody that has gotten a connection? Do you see any possibility for cooperation?



**Wilder:** Sadly, no. Of course, the main challenge is that it would be illegal. We live in a climate where violation of a Terms of Service agreement can result in a Federal indictment, so it doesn't seem worth it to risk it. What has happened is that, the public housing authorities, in addition to a really big chunk of the public have realized that while a decent number of folks, or people acting on

their behalf, were able to come up with the ten bucks to preregister – the shit has really hit the fan when it comes to actually getting the connections. People simply don't have the money. It's not happening. From my perspective, the reality on the ground is that where the city needs it most, very, very few people are getting connected. It seems more urgent than ever that there be some solution for ambient connectivity, and I think that's a big part of why there's so much energy behind what we're doing.

**COOK Report:** People are aware of the disparity, and they're thinking about what they can do about it?



**Wilder:** It's that, and they're also just coming to terms with the fact that a very small portion of the population is going to be helped at all by Google Fiber. That's the bottom line.

**COOK Report:** Well, it's going to be extremely interesting, that's for sure. So, to what extent is there going to be the possibility that there will be some middle or high school where some of the students have a Google Fiber connection at home, and others have nothing at all?

**Wilder:** It seems fairly likely, although Kansas City remains a deeply segregated city, by race and by class. Given that Google's map drawn on those same old race lines, I imagine that there won't be much overlap demographically. It's far more likely that some kids will go from a home where they have no connectivity at all to a school where they've got Google Fiber, and back to nothing in the evening.

# It Must Be Done

## *A Summary and Credo by Isaac Wilder*

Much of the material in this report has been gleaned from conversations, from clippings, from the outside looking in. This is my opportunity to look out, to tell you where we stand, what moves us, and why what we're doing matters immensely.

The first thing to understand is that we're in this for the long haul. We're just going to keep going, no matter what. Understand that we are dedicated to the idea of the network as a public good as deeply and as passionately as individuals can be dedicated to an idea. From my perspective, the reason is simple: what we've got today is broken, badly. It is downright painful to see the state of our knowledge infrastructure. For the first time in all history, we have the capacity easily within our grasp to make sure that no mind ever again goes hungry for knowledge. With this understanding, that we do not have to be beholden any longer to those that would deny us the the profound and sacred gift of knowledge -- *we cannot remain idle*.

There is no reason - technical, social, economic or otherwise - that connectivity should not be regarded as a universal and public good. It seems self-evident that the consequences of such a regard would serve to profoundly augment human flourishing. Someday, I am sure, there will be a global network, maintained through the voluntary association, goodwill, and self-interest of all. For the time being, it begins with the community, the locality, the tribe.

Horizontally organized network commons have been built using copper, fiber optics, free space optics, microwaves, and many other media of transmission. Much of the focus has been on microwave wireless, including fixed and mobile applications, where dramatically lower capital costs put larger buildouts within the reach of ever smaller enterprises.

What was a newfangled and far-fetched idea just a decade or so ago, that communities can do for themselves what has long been the job of telecommunications giants, is now a manifest reality. Large scale community networks have blossomed, while the technical and economic barriers to their growth lessen, accelerate the decline of the giants. As the barriers come down, the networks go up - it is only logical: why would billions of humans continue to rent their ability to communicate, when they could as easily come to own such a capacity for themselves?

What we are witnessing is no less than the emergence of a global mind - the impulse to demand rent for the use of communications pathways holds us back as a society and a species. The problems we face are too large, and the situation is too dire to think that we

can afford to do anything less than reckon fully with our troublesome dependence on those that would keep us in a version of 21<sup>st</sup> century serfdom.

It almost goes without saying that information is now, more than ever, the engine that moves the world. With electricity, with heavy industry, with agriculture before that, the way that we relate to our most advanced technologies is necessarily reflective of the macro power structures of civilization.

We intend to challenge and transform those structures, and we believe that DIY internet is exactly the right place to start. Those who do it have a stake in the outcome. They become producers rather than just detached consumers. Organization starts with communication, and our lines of communication cannot be contingent on the cooperation of entities whose paramount interest is the indefinite perpetuation of the *status quo*.

There is very much work to be done. We have the tools that we need to get started, and to have an immediate impact on the lives of many, but the fact remains that we need better tools. We have, first and foremost, to make it easier to build free networks. There are only so many folks that are willing and able to learn the technical aspects of computer networking – there are many more, (though still a limited number) that would be willing to organize their communities, if only they had the right tools. I make this assertion based on the notion that late capitalism leaves most all of its subjects in a state of deep discontent. Given the choice to continue acting as a born-and-bred consumer drone, or to take part in the construction of something new and world-changing, it is doubtless that most will drone on – a few though, will find meaning in the work of species-scale cooperation. We have to make it possible for those few to contribute in a meaningful way.

More than that, we need to push the very limits of what is possible. The microwave hardware available today off-the-shelf is intended for use in contentious networks, where radio signals interfere and collide with one another by design. Looking towards the horizon, it is critically important that we increase the practicability and decrease the cost of radio systems that are spectrum-sensing, adaptive, and cooperative. Ultimately, it will be essential that we produce systems in which capacity goes up in at least a linear relation to the number of nodes. Such systems have been proven theoretically, but at the level of physics and media access, today's systems don't come close.

We know that there is very much to do, and it is for this reason that we are taking care to build as solid a foundation as we possibly can. We are gearing up for a struggle. From where we stand, this is something that simply has to happen. If we are to save the planet from ecological disaster, if we are to achieve social justice, if we are to live free, we simply must make provisions for a network commons born of social production.



## A Note from the Editor:

I strongly endorse Isaacs credo as written above. As corporation go Google is superb. However, being publicly held it must according to current belief act to benefit its shareholder first of all. I know Milo Medin and sent him a final draft of this article. Not surprisingly he disagreed with Isaacs comments about his company. In my opinion set of actions can be viewed differently by people on different sides of the economic fence. I think that is the situation here. A desirable end would be for FNT and Google to cooperate. In the meantime perhaps they could use connecting for Good as neutral ground for conversation. Isaac is giving the community organizations which he works with a strong stake in the outcome. This is good. It is something that I would like to see a lot more of. Citizens rather than corporations would be likely to come out the winners - an outcome that we seldom see these days. If our nation is to survive on the basic principles drawn up by the founders it is something we need to see happen much more.

# Conclusion

*Not an End but a New Beginning* by Jeff Michka

## Why to “Do-It-Yourself” and Really Practice “Do-It-Ourselves”

Both gufi.net and Kansas City FreeNet are examples, illustrated in real terms, that creating networks and connectivity, oriented toward user needs and, in large measure created by users, are true alternative paths to the connectivity provided *exclusively* by corporate entities motivated by simple profits and market share.

These new user-created networks are not only technically possible, but practical in application – built not because networks are “cool” and everyone ought to have one, but because building them would address mutually recognized and shared problems of those served by the networks.

Like most innovative approaches to applied technology, both concepts (guifi.net and Kansas City FreeNet) were born of the desires and needs of those providing seeds for their network development. Neither were these networks created to carve out personal empires of wealth and control or meant to be springboards to position, big salaries and stock options at the eventual expense of the constituencies served. As a result, their network designs, development and deployment were products of the old, tried and true reality of “form follows function.”

In Catalonia, Ramon Boca started because he wanted to telecommute from his regional residence of choice, and could not. Ramon intuitively struck out to find a solution resulting in guifi.net. Here in the United States, Isaac Wilder’s journey began as part of his political/social perceptions, combined with deep passions for social justice and change in other causes.

The two efforts detailed in this issue of *The Cook Report* face both technical and non-technical challenges and other issues hovering in the background that must be kept in mind when examining or comparing them. Perhaps most important are the economic, cultural, social and political differences between Catalonia (and EU) and those found in the United States.

Other issues affect efforts mostly here in the US, and are worth only passing acknowledgement due to their nature and scope, but must be kept in mind. For example, although a stated reason for creating Kansas City FreeNet, was filling in for what Google would not be doing, it seems pointless to obsess over behaviors of Google or other heavily-monetized, extractive corporate entities that are designed to create a profit for their owners. This goal is why commercial, for-profit enterprises exist.

Here and elsewhere in the World, corporate, capitalist entities will continue to do what they do best: Make money. Making money will always be their goal. Given cost and profit models, they will tend to serve those that can pay (and pay and pay), and will either underserve or not serve people, neighborhoods, communities and regions where – regardless of reason – individuals are unable to pay as contribution to meet corporate-defined profit margins.

In the US, or in Catalonia with Spain's Telefonica, it should come as no surprise to anyone that telcos and cable companies will act like telcos and cable companies have always acted or tried to act: like monopolies any time given the chance. With continued federal regulatory dysfunction at FCC in the United States, and recognizing a higher and almost total dysfunction at a federal legislative and policy level, nothing will effectively stop these giants from behaving as predatory monopolies, despite any individual efforts.

At US state regulatory levels – PUC/UTC commissions – the same monopoly players have other factors in their favor. Like virtually all state and local governments, monetary resources have become scarce.

Money in budgets equals FTEs (Full Time Employees). Knowledgeable and competent staffs supporting state regulatory agencies have fallen under the budget axe. At best, wise counsel from staff has been almost eliminated in many states, and with almost unlimited capital resources, it becomes far easier for MSOs and other incumbent telecommunication providers to hold absolute sway over the regulators and elected officials. As a result, and at best, state regulators and elected officials will accept what MSOs and incumbents tell them, regardless of how erroneous proponent arguments might be in absence of any countervailing voices, even from staff. So-called public interest or real, direct-to-the-public-benefits are usually the first victims in these environments.

At a municipal level, even scarcer monetary resources may mean any corporate-tied offer "to do something at reduced cost" becomes almost impossible to resist, even though it's obvious the citizens these local elected officials ostensibly serve will not all be served by the corporate entities they curry favor with. The cities get an offer they can't refuse. They can have their cake consisting of restricted-access or very limited-access municipal networks or broadband access without investing much of the jurisdictional dollar, and eat all of it too.

These trends are not going to change any time soon, and again, no single effort will undo or stop these aforementioned trends. The trends must be kept in view, but not obsessed over as a total distraction from the business of creating and deploying new networks as remedies where necessary.

Given the necessity for people to access information and other products the Internet offers -- for example job info and applying for work, medical info and social services, education opportunities including free university courses -- price and access are barriers with long-term negative and almost tragic socio/economic consequences. Kansas City FreeNet

and guifi.net models provide some way out for those trapped by location, economic and social status, as well as directly involve affected people in creating their own solutions. In full recognition of governments being no longer to provide workable solutions or answers, these network models become clear and practical alternatives with many more potential benefits to those involved in their creation.

## **We've got the Tools and Talent: We Are Not Alone**

In long-held traditions having little to do with the Internet, guifi.net and Kansas City FreeNet have decided to build alternative networks on what they call a "Do It Yourself" (DIY) basis.

The technological means to create networks employing the "DIY model" as Ramon and Isaac call it are clearly detailed in this issue of ***The Cook Report***.

For tinkerers or home owners anywhere, DIY can be a cost effective and deep, personally satisfying effort when a success, and even when things don't quite work out. Ask someone who put on their own roof, then finds it leaks. The reaction is "I'll fix it and make it better next time," or they may just put down a few buckets, still glowing with personal satisfaction, then fix the problem later. But DIY, despite outcome, is still a singular effort defined and limited by the word "Yourself."

Is it fair to say these alternative network initiatives are really just "Do It Yourself"?

Neither Ramon nor Isaac would say of their visions, "I built this." There are many other individuals and organizations making up the vital constituencies of both models and participating in their genesis and growth. Ramon clearly acknowledges this within the guifi.net's "Three Pillars."

Both visioners would be the first ones to admit it. A whole lot of people – technical professionals and individuals are working in concert, building and deploying these networks, whether pulling fiber in Catalonia or putting up radio antennae or doing signal strength studies in Kansas City.





## Wouldn't it be Far Better to Say "*Do It Ourselves?*"

Do It Ourselves (DIO) is an important and powerful phrase through which to view many, if not all aspects of guifi.net and Kansas City FreeNet. It's an important and crucial up-front statement not only to those viewing these networks, but by people with technical expertise and those without that background, creating them from the bottom up to ensure, in total, ***the network remains as means to end, and not an end in itself.*** It's not just the network, it's *everyone* involved in making it happen.

The phrase "Do it Ourselves" conceptually helps break down participant barriers created by potential self-aggrandizement and self-interest at the front end with a single phrase. It's an important premise in design and deployment as part of an *overall* project environment, signaling from the outset we are not alone in these pursuits, and taking it into account at every phase of the project.

Do it Ourselves is a signal to all participants that, by default, they must commit to working with each other and learning about the tasks at hand. This requires professionals to reach out and teach, too. No, few "average" people will embrace or be able to grasp difficult technical concepts and procedures, but some will want to try if encouraged and sustained.

DIO is an equally vital way to view long-term network resilience, sustainability and reasoned growth – what can be done and by whom – as the network is deployed and matures. It's a simple way to look at how these and other similar efforts can govern themselves, introducing Commons principles as organizational covenant, structure and guidance for how these networks develop and are used over time.

DIO sets a tone for how participants will see their efforts from the beginning and looking back at results: **We did it ourselves.**

A DIO attitude and effort is particularly important in the US.

Here, people do not have the same social compacts and experiences of those in Catalonia where cooperative behaviors are accepted and traditional ways of going about things in agriculture and related pursuits, having absolutely nothing to do with the Internet or building alternative networks.

As a result of this difference, in the US, alternative network development of any technical flavor – mesh wireless or hybrid variants -- will have to go hand in hand with some very basic grassroots-organizing techniques, education along with technical evangelism, even in locations with strong neighborhood and community organizations. People will need to be educated and convinced as to how cooperative action, Commons principles and open access can directly benefit them and how, respective of the technical aspects of the network itself.

It can be done, but adds an additional layer of complexity probably not found, for example, in Catalonia. For alternative network proponents in the US, Ramon Boca's observation "If we take on a new project and don't provide positive results, the local people we're trying to work with will get discouraged" must also be taken as a very basic organizing principle and consideration.

Promising too much in too short a development curve without tangible results will discourage constituents, no matter where, so developers need to carefully map out progress and define expectations well in advance.

This consideration becomes important when mesh wireless-only networks are the mechanism of choice (or necessity). Although a mesh wireless network is easier to create, particularly with out-of-the-box tools like those software tools guifi.net has developed, and with less expensive hardware costs and deployment, some pretty steep expectation challenges could impact results.

For example, mesh wireless-only network performance and service levels will remain issues. If people's expectations are that they will stream Netflix HD 24/7 as a primary use of these networks they helped build, then they might well be disappointed. If the expectations are that high school students will no longer have to stand outside their school to use a nearby business' wi-fi hotspot to do homework or apply for work or college, then people might be well satisfied with results of their efforts and want to do more. ***People may be well satisfied if technological limitations do not compromise why the network was created to begin with.***

Other challenges, far more transparent to constituents and neighborhood stakeholders less than tech-savvy, but of great concern to professionals, include problems of crowding 802.11 category spectrum, and perhaps as a result, the future practical use of unlicensed spectrum in general, even considering innovations in spectrum usage with software-defined radio.

Guifi.net, given the political and regulatory environment in Catalonia or EU nations in general, can deploy their own fiber as needed to ensure performance and interconnection. Do it Ourselves broadband initiatives are being encouraged in EU, while discouraged by default and other factors in the US. See <http://dev.bub4eu.net/>

Wireless mesh interconnection in the US will require some really creative work-arounds and efforts on the part of alternative network proponents and technical personnel if Commons principles (at several levels, including content licensing), open source and P2P networking are deliberate functions of overall network design and intent. It's a big challenge to successful wide deployment.

Can it be solved here in the US? That remains to be seen over time.

## Taking Time

Mentioning “over time” brings up another “challenge point of comparison” between Kansas City FreeNet and guifi.net. Guifi.net has taken 10 years to develop to where they are now. Kansas City FreeNet, has existed for just months.

Isaac Wilder should be complimented on Kansas City FreeNet coming so far so quickly. It's remarkable in many ways. It does beg questions on how they will structure themselves to grow, given *all* factors, and remain vital and active in neighborhoods and in the wider community they serve. Those questions are not answered yet, but this is no surprise given how early-on the effort is. Their efforts cannot be judged exclusively for this reason alone, and must be applauded.

Again, Do it Ourselves attitudes may be a key as to how this happens over the long haul in Kansas City or elsewhere in the US. The real strength of these networks will not be measured by just the technical framework and professional-level individuals building frameworks, but measured by the combined strength and effort of *all people and groups actively involved* with making them happen.

As an adjunct to ensuring involvement, and keeping in the spirit of promoting network as Commons, alternative network proponents must embody Commons concepts in their covenants and operating agreements.

Guifi.net, in 2006 adopted their Comuns XLON, a covenant and contract between and among all participants that clearly states purpose of a declared Commons, and codifying an open-access, peer-to-peer network. The covenant spells out participant responsibility to the network and other participants in guifi.net.

Roger Baig Viñas of guifi.net describes guifi.net projects attraction and the evolution of the commons concept pre-adoption and its eventual codification:

“ I decided to join [guifi.net](http://guifi.net) the same day I knew about the project because it offered me a clear hands-on project, a clear way to start working for changing things. The problem to address was pretty well defined: a key infrastructure (“the internet”) that has been hijacked by a few companies and lobbies (Telefonica in the very first place, followed by Orange, etc.) and an incipient technology (“the WiFi”) becoming available to start building and alternative, not only to do things as they had to be done by a theoretically sane capitalist system but much better. At that time we hadn't had the theoretical fundamentals as we have now (built mainly around the Commons concept) but we had the intuition (thanks to the clairvoyance of Ramon - and maybe a few others) that we were doing the things the right way. It's been during this process of theorization combined with an intensive fieldwork that we (at least I) understood that our model (the model based on Commons) could easily be extrapolated to many other areas, infrastructures, and services. Actually I am not able to think about any area where it cannot work. As I already said to you, one of the things I like the most is the fact that this model both enables and needs commitment from the people.”

This type of agreement, other than ensuring open access and interconnection, is a means of promoting Commons thinking and can, as covenant, also ensure a level of trust among participants. This element of trust-by-covenant principle is a big step in trust building be-

tween constituents, taking the place of corporate, for-profit Terms of Service (TOS), for example.

Too often, TOS in a for-profit MOS setting is ignored until some problem arises, and is then used as a club or excuse to bar access, resolve “problems,” or deny responsibility. The same corporate entities are also the first to break trust with consumers when it comes to promised deployments, rate hikes and system performance, to name three frequently broken deals.

An elegant and reasonably simple agreement like guifi.net’s Comuns XLON states all requirements and expectations upfront. When combined with stated goals and reasonable expectations of results from an alternative network, an extremely powerful package has been created to build trust and ensure behavior by **all** participants that lend to Commons thinking in real application.

In addition, particularly in the US, the same clear and purposeful declarations should be included in a alternative network’s incorporation bylaws, regardless of what non-profit tax classification (for example, 501c(3) or 501c(10)) they choose to take as their legal structure.

Although guifi.net’s thinking evolved over time, this???? is not necessary any longer given their outstanding example. As Roger has pointed out, it can be applied anywhere. This too must be part of alternative network development from the beginning.

Once again, these covenants have little to do with the technical aspect of a network, but have everything to do with ensuring success in the face of some very daunting but exciting challenges to deployment and potential promise.

Can guifi.net come to the US and succeed? Yes. Can many Kansas City FreeNets flourish? Yes.

Will it be easy? Probably not, but development and deployment of these alternative networks is absolutely necessary to break the weight of corporate chains and roadblocks to an open access Internet based on Commons principles and the free

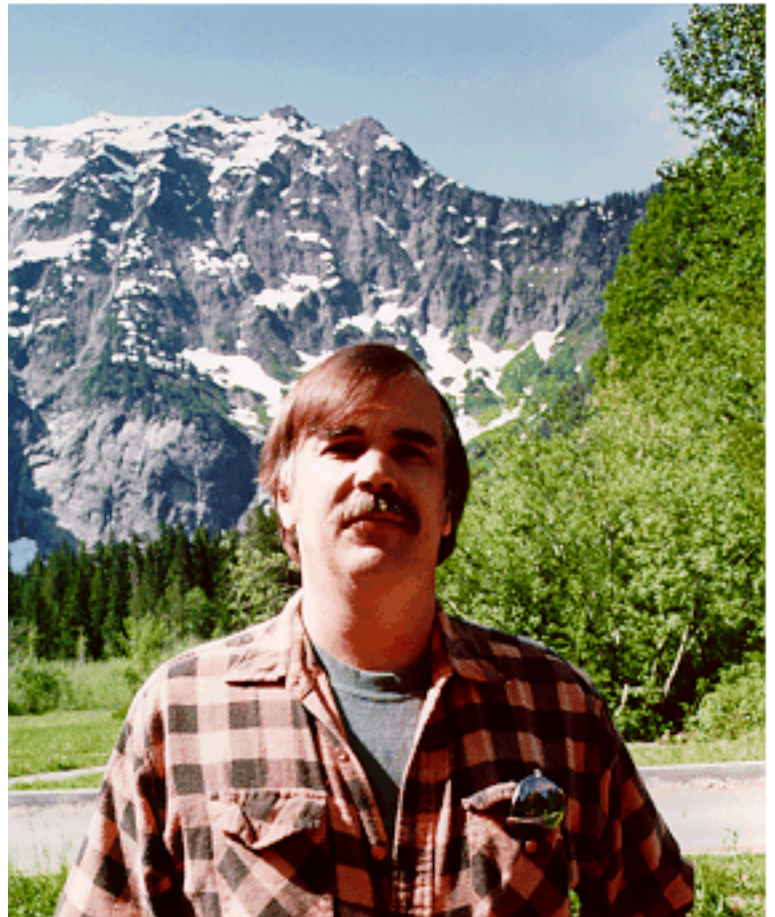



exchange of ideas, hence liberating those that are not yet served and as well as those treated as digital serfs and passive consumers ripe for fleecing, in the US and around the World.

If not now, when? The time has come today.

**Jeff Michka and the Editor went hiking in 1993.**